

# Index

产品目录 PRODUCT CATALOG



## 极窄系统系列

35 极窄平开门系列 —	01/03
35 极窄推拉 / 吊趟门系列	04/08
40 极窄平开门系列 —	09/11
40 极窄推拉 / 吊趟门系列 —	12/15
45 极窄平开门系列 —	16/18
45 极窄推拉 / 吊趟门系列 — —	19/24
45 老铁门装饰条系列 —	25

## 中窄系统系列

35x48 平开门系列 (壁厚 0.8/1.0/1.2/1.4) —	26/29
35x48 推拉 / 吊趟门系列 (壁厚 1.0/1.2/1.4/2.0) —	30/33
35x65 平开门系列 (壁厚 1.2/1.4) —	34/36
35x65 推拉 / 吊趟门系列 (壁厚 1.2/1.4/2.0) —	37/40
35x65 封窗系列 —	41/44
42x65 重型平开门系列 — —	45/46
42x65 重型推拉 / 吊趟门系列 — —	47/49
隔断平开门系列 —	50

就是这样子装的

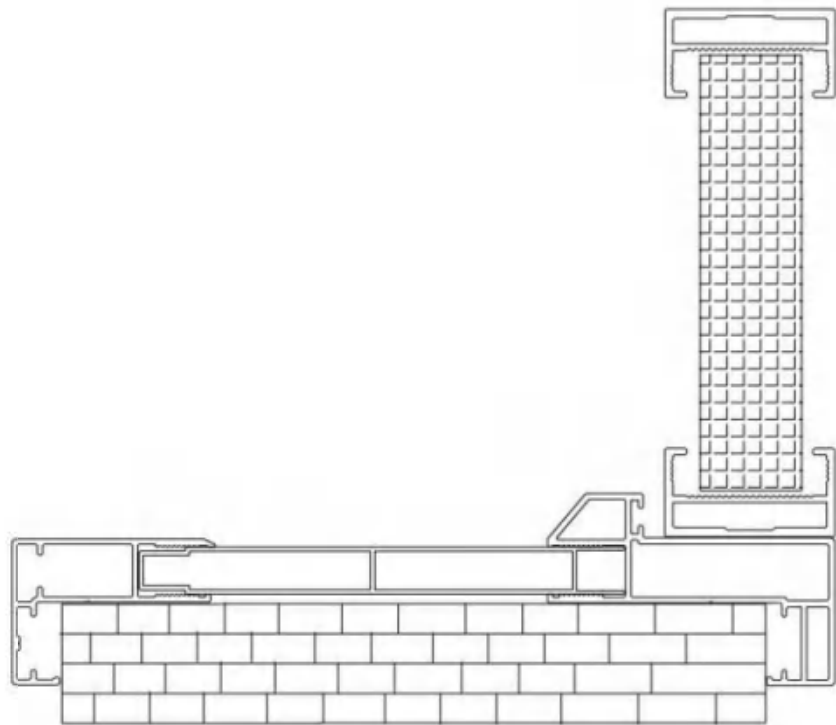
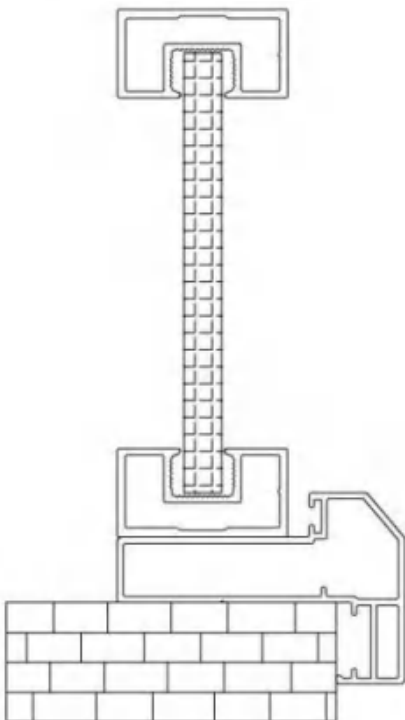
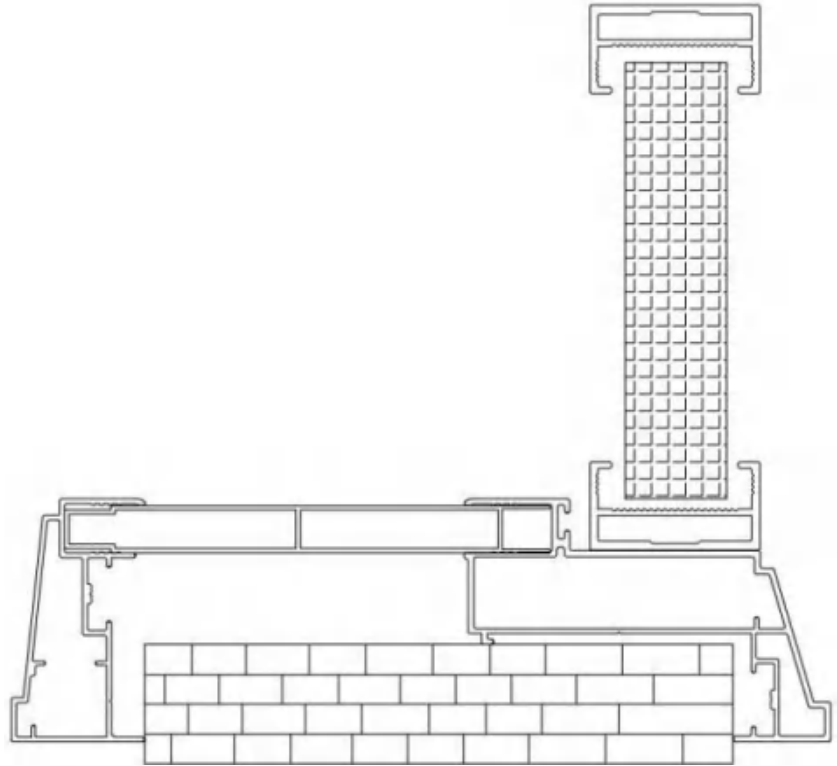
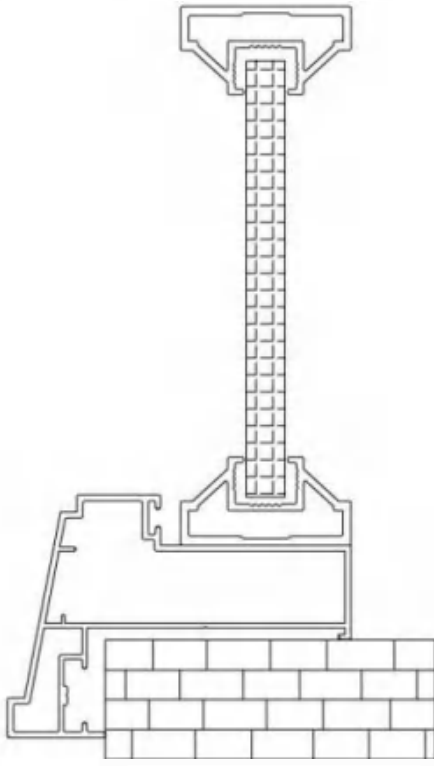

# 35 极窄平开门系列

高端系统门窗 - 定制极窄铝型材  
High-end system doors and windows - custom ultra-thin aluminum profiles

现货颜色：玳瑁黑、玉瓷灰、月光灰、星空咖啡、玳瑁白、威法金、瓷美银灰  
其他颜色可订制！



努力鸭 奋斗鸭！

<p>型号:LBW053 名称:单玻光企 壁厚:1.9mm 重量:0.466kg/m 长度:4.8m</p>	<p>型号:LBW159 名称:35单玻光企(平) 壁厚:1.9mm 重量:0.523kg/m 长度:4.8m</p>	<p>型号:LBW056 名称:双玻光企 壁厚:1.9mm 重量:0.436kg/m 长度:4.8m</p>	<p>型号:LBW080A 名称:正包框 壁厚:1.2mm 重量:0.801kg/m 长度:6.4m</p>																
<p>型号:LBW077A 名称:包套(前框) 壁厚:1.0mm 重量:0.489kg/m 长度:6.4m</p>	<p>型号:LBW081A 名称:后框/反包 壁厚:1.3mm 重量:0.84kg/m 长度:6.4m 做反包配套 LBW082</p>	<p>型号:LBW082 名称:反包底座 壁厚:1.0mm 重量:0.214kg/m 长度:6.4m 配套 LBW081A</p>	<p>型号:LBW152A 名称:超窄正包框 壁厚:1.3mm 重量:0.698kg/m 长度:6.4m</p>																
<p>型号:LBW157 名称:前框/包套 壁厚:1.05mm 重量:0.436kg/m 长度:6.4m 配套 LBW149, LBW155, LBW181A</p>	<p>型号:LBW153A 名称:超窄后包框 壁厚:1.3mm 重量:0.759kg/m 长度:6.4m 做反包配套 LBW154</p>	<p>型号:LBW154 名称:反包F槽 壁厚:1.1mm 重量:0.113kg/m 长度:6.4m 做反包配套 LBW150A, LBW151A, LBW152A, LBW153A, LBW273</p>	<p>型号:LBW099 名称:平开门收口 壁厚:1.0mm 重量:0.441kg/m 长度:4.8m</p>																
<p>型号:LBW046A 名称:100扣板 壁厚:0.8mm 重量:0.498kg/m 长度:6.3m</p>	<p>型号:LBW046B 名称:120扣板 壁厚:0.8mm 重量:0.622kg/m 长度:6.3m</p>	<table border="1"> <thead> <tr> <th>35 极窄平开门锁</th> <th>35 极窄平开门配件</th> </tr> </thead> <tbody> <tr> <td>PK-01159(单玻平开锁-平面)</td> <td>光企角码:JM-0635(31.3x4.5)</td> </tr> <tr> <td>PK-53(单玻平开锁-斜面)</td> <td>外框胶条:JT-50151</td> </tr> <tr> <td>PK-8656(双玻平开锁)</td> <td>外框组角片:Z-4450(14.6x2)</td> </tr> <tr> <td></td> <td>外框角码:JM-80-1(配LBW080A/LBW081A)</td> </tr> <tr> <td></td> <td>外框角码:JM-152-1(配LBW152A/LBW153A)</td> </tr> <tr> <td></td> <td>LBW77A包边角码:JM-77(14x14)</td> </tr> <tr> <td></td> <td>LBW157包边角码:JM-157(18x10.5)</td> </tr> </tbody> </table>		35 极窄平开门锁	35 极窄平开门配件	PK-01159(单玻平开锁-平面)	光企角码:JM-0635(31.3x4.5)	PK-53(单玻平开锁-斜面)	外框胶条:JT-50151	PK-8656(双玻平开锁)	外框组角片:Z-4450(14.6x2)		外框角码:JM-80-1(配LBW080A/LBW081A)		外框角码:JM-152-1(配LBW152A/LBW153A)		LBW77A包边角码:JM-77(14x14)		LBW157包边角码:JM-157(18x10.5)
35 极窄平开门锁	35 极窄平开门配件																		
PK-01159(单玻平开锁-平面)	光企角码:JM-0635(31.3x4.5)																		
PK-53(单玻平开锁-斜面)	外框胶条:JT-50151																		
PK-8656(双玻平开锁)	外框组角片:Z-4450(14.6x2)																		
	外框角码:JM-80-1(配LBW080A/LBW081A)																		
	外框角码:JM-152-1(配LBW152A/LBW153A)																		
	LBW77A包边角码:JM-77(14x14)																		
	LBW157包边角码:JM-157(18x10.5)																		

就是这样子装的

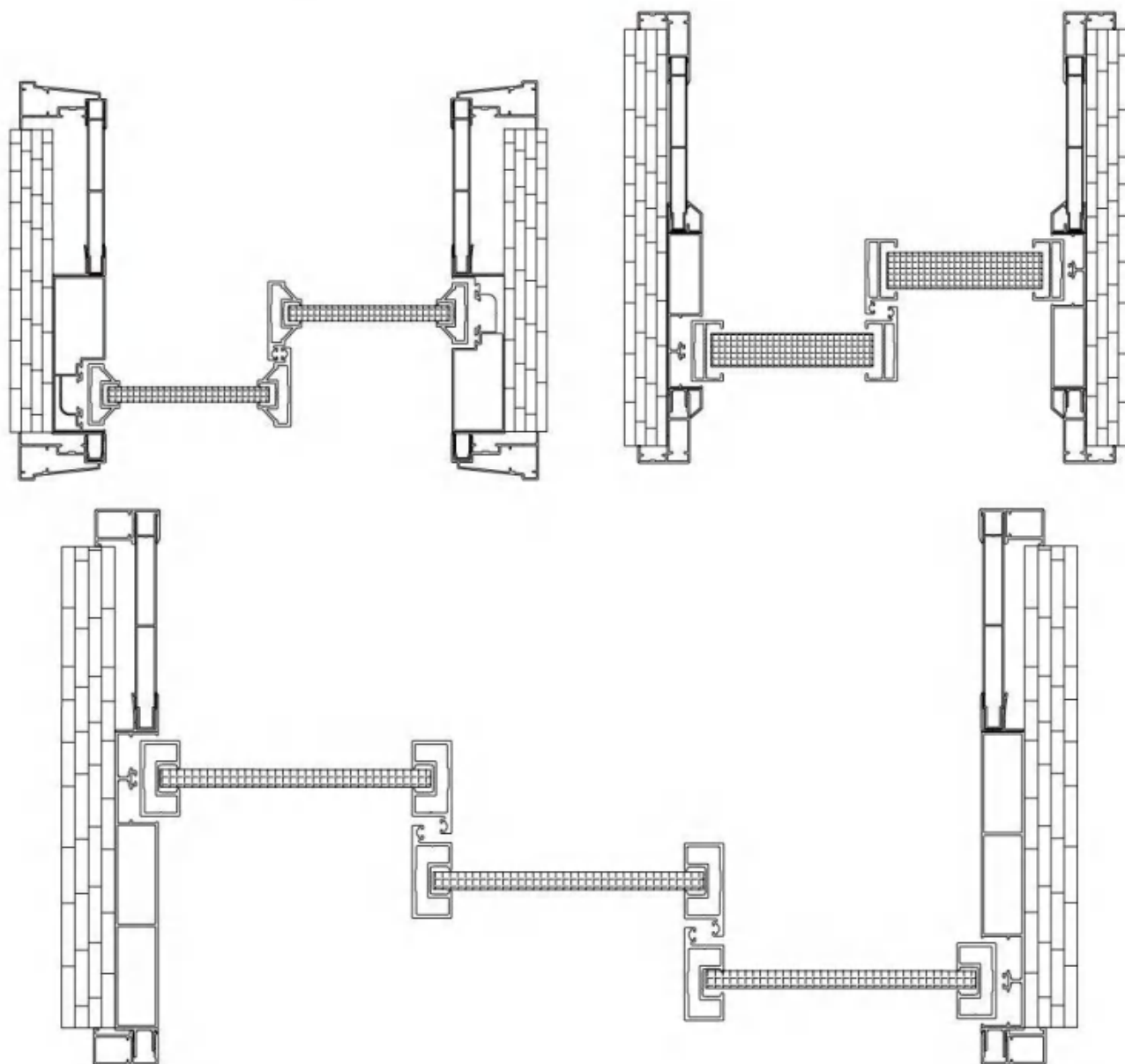
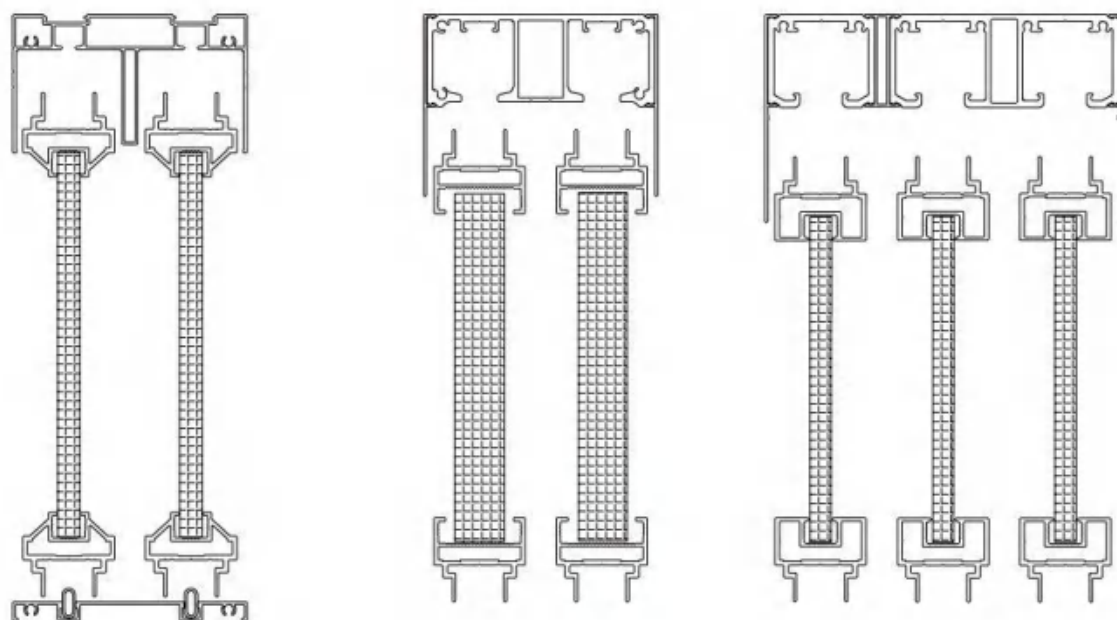

## 35 极窄推拉 / 吊趟门系列

高端系统门窗 - 定制极窄铝型材  
High-end system doors and windows - custom narrow aluminum profiles

现货颜色：玳瑁黑、玉瓷灰、月光灰、星空咖啡、玳瑁白、威法金、瓷美银灰

其他颜色可订制!

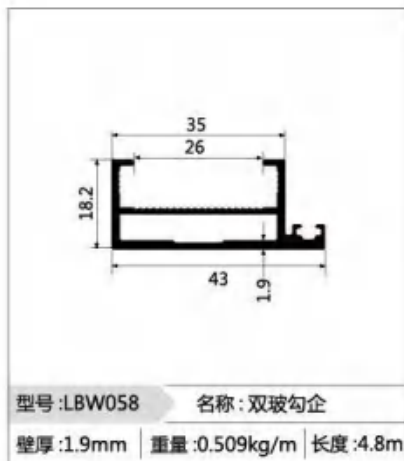
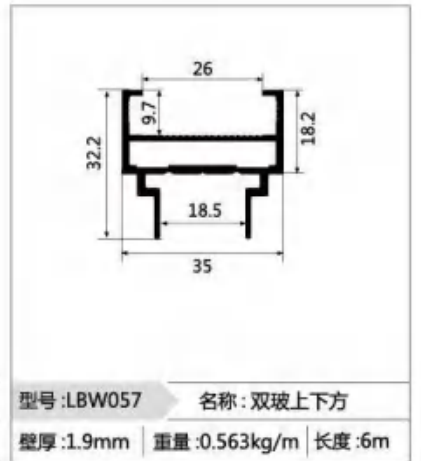
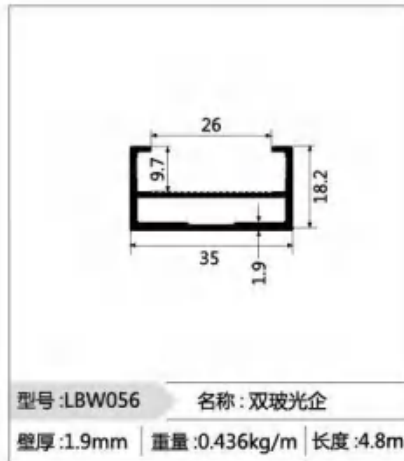
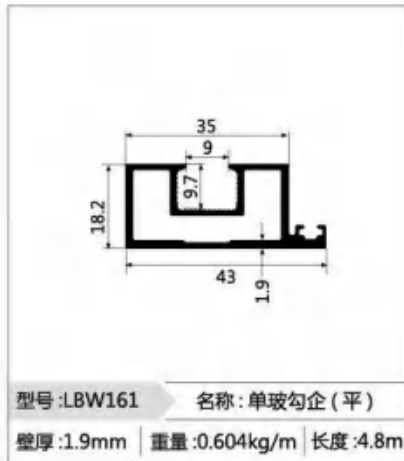
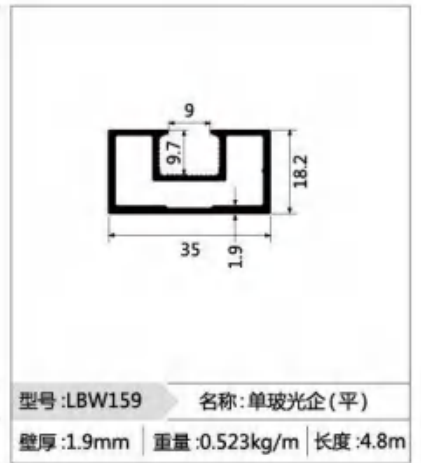
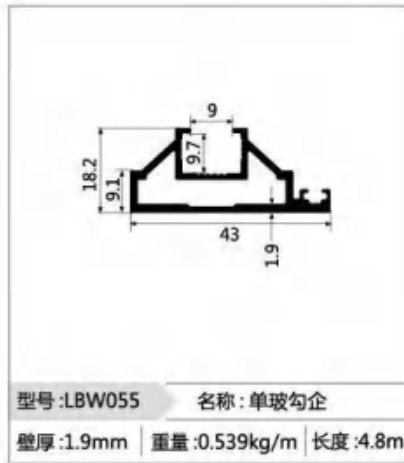
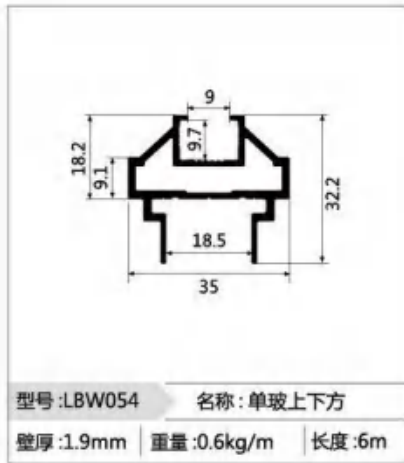
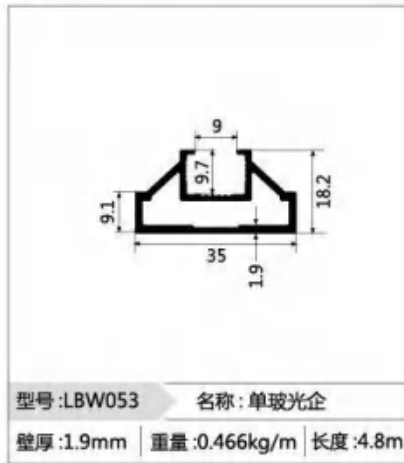

35 极窄推拉门配件	
拉手锁(点锁配3分边封)	LSS-159A(玳瑁黑)
	LSS-53A(玳瑁黑、月光灰、玉瓷灰、玳瑁白、星空咖啡)
	LSS-56A(配套铝材颜色)
拉手锁(钩锁配2分边封)	LSS-159B(配套铝材颜色)
	LSS-53B(玳瑁黑)
	LSS-56B(配套铝材颜色)
光企角码:JM-0635(31.3x4.5)	转角磁条:ZJ-01
上轮:SL-01	157包边角码:JM-157(18x10.5)
下轮:XL-01-2(两轮),XL-01-4(四轮)	158/158A角码:JM-158(11.6x14)
勾企胶条/边封胶条:JT-4058262(3.8)	158A组角片:ZJP-158A(9.5x1.0)

现货颜色：玳瑁黑、玉瓷灰、月光灰、星空咖啡、玳瑁白、威法金、瓷美银灰

其他颜色可订制!



玳瑁黑



玉瓷灰



月光灰



星空咖啡



玳瑁白



威法金



瓷美银灰



现货颜色：玳瑁黑、玉瓷灰、月光灰、星空咖啡、玳瑁白、威法金

其他颜色可订制!



努力鸭 奋斗啊!

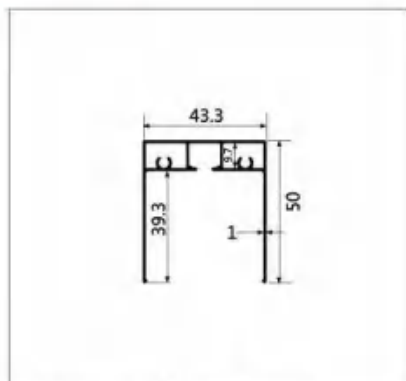

型号:LBW090 名称:单上轨  
壁厚:1.0mm 重量:0.587kg/m 长度:6m

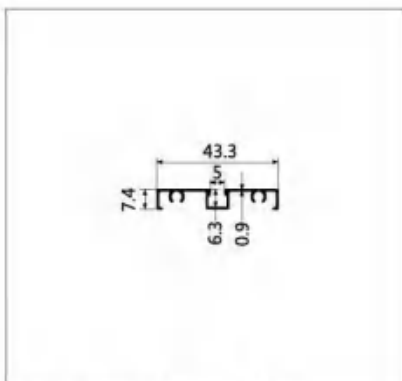

型号:LBW091 名称:单下轨  
壁厚:0.9mm 重量:0.233kg/m 长度:6m

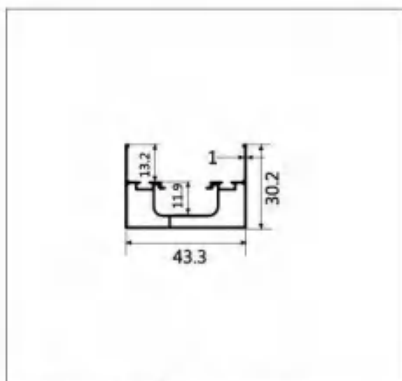

型号:LBW092 名称:单边封  
壁厚:1.0mm 重量:0.48kg/m 长度:4.8m

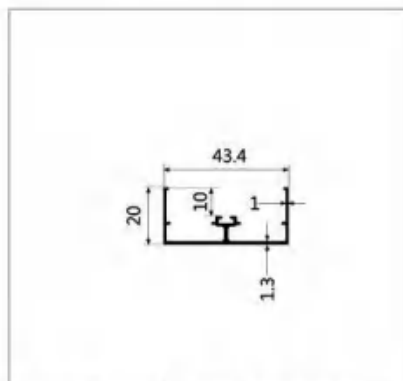

型号:LBW164A 名称:2公分单边封  
壁厚:1.0mm 重量:0.34kg/m 长度:4.8m

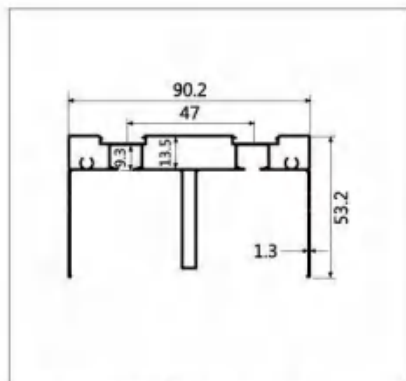

型号:LBW059 名称:双上轨  
壁厚:1.0mm 重量:1.186kg/m 长度:6m

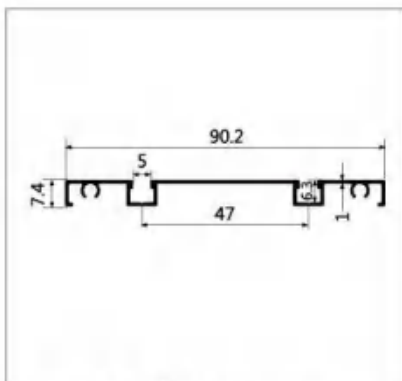

型号:LBW060 名称:双下轨  
壁厚:1.0mm 重量:0.416kg/m 长度:6m

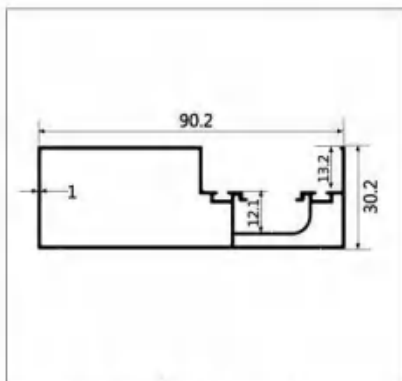

型号:LBW061 名称:双边封  
壁厚:1.0mm 重量:0.791kg/m 长度:4.8m

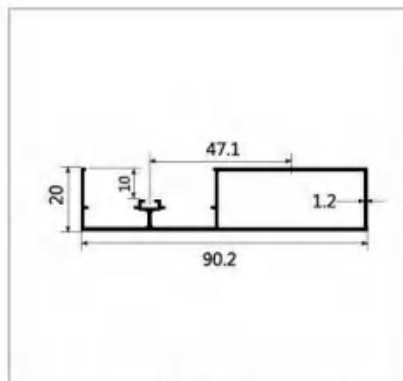

型号:LBW163A 名称:2公分双边封  
壁厚:1.2mm 重量:0.7kg/m 长度:4.8m

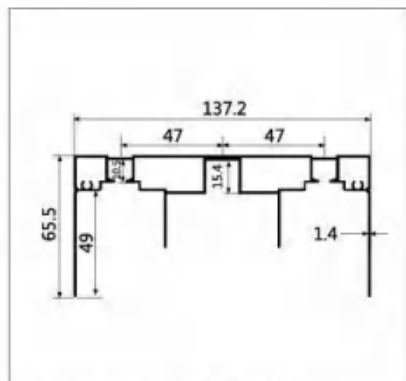

型号:LBW162 名称:三上轨  
壁厚:1.4mm 重量:1.782kg/m 长度:6m

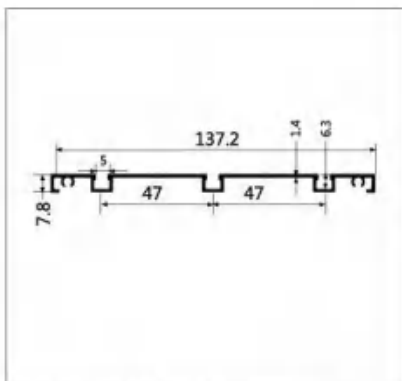

型号:LBW083 名称:三下轨  
壁厚:1.4mm 重量:0.791kg/m 长度:6m

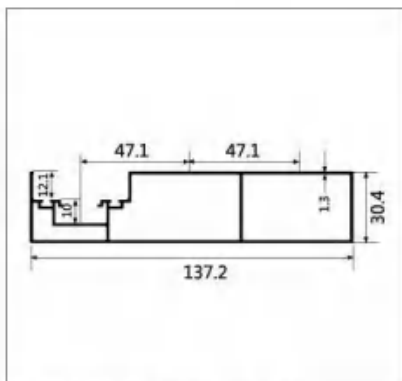

型号:LBW068 名称:三边封  
壁厚:1.3mm 重量:1.37kg/m 长度:5.2m

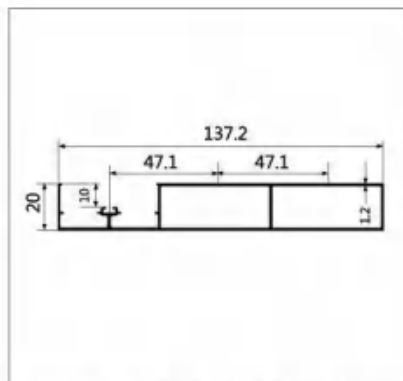

型号:LBW165A 名称:2公分三边封  
壁厚:1.2mm 重量:1.063kg/m 长度:5.2m

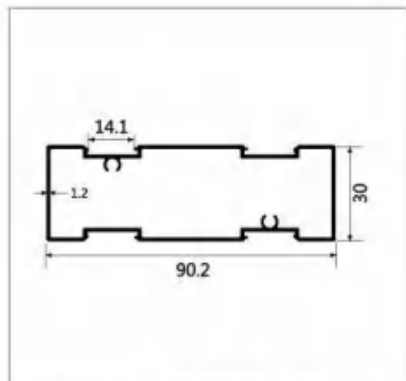

型号:LBW100 名称:两轨中柱  
壁厚:1.2mm 重量:0.92kg/m 长度:6m

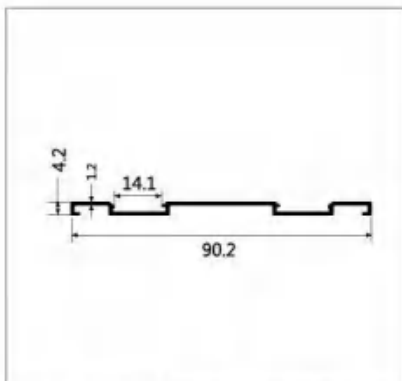

型号:LBW100A 名称:两轨中柱盖板  
壁厚:1.2mm 重量:0.376kg/m 长度:6m

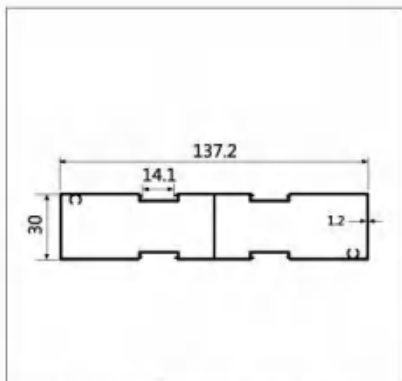

型号:LBW101 名称:三轨中柱  
壁厚:1.2mm 重量:1.31kg/m 长度:6m

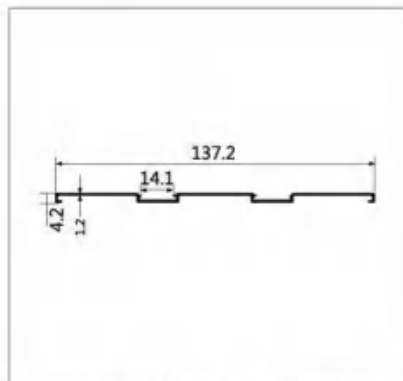

型号:LBW101A 名称:三轨中柱盖板  
壁厚:1.2mm 重量:0.533kg/m 长度:6m

# 35 极窄推拉 / 吊趟门系列

高端系统门窗 - 定制极窄铝型材  
High-end system doors and windows - custom ultra-narrow aluminum profiles

现货颜色：玳瑁黑、玉瓷灰、月光灰、星空咖啡、玳瑁白、威法金

其他颜色可订制!

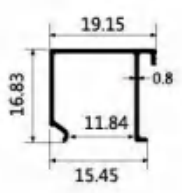
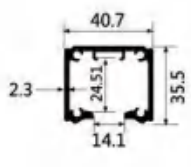
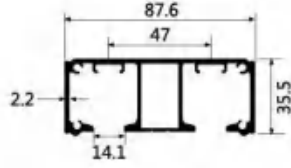
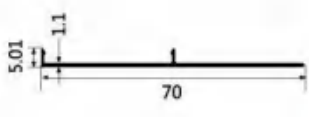
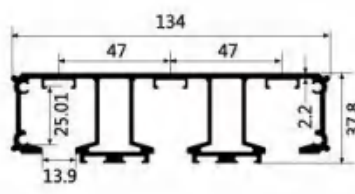
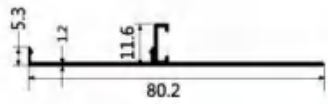
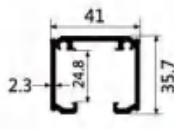
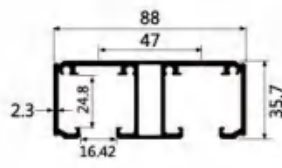
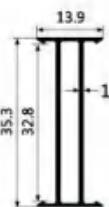
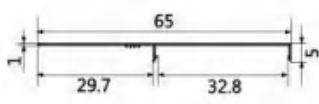
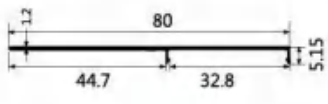
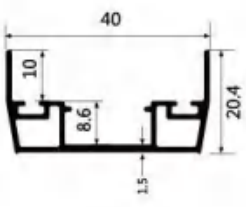
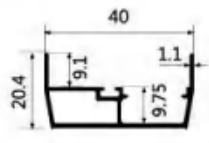
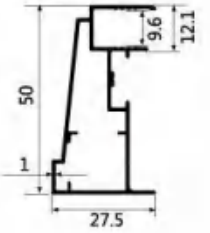
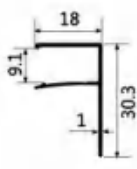
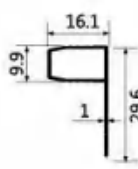

	<p>颜色：黑珍珠</p> 	<p>颜色：黑珍珠</p> 	 <p>配套 LBW063 LBW062</p>
<p>型号:LBW094A 名称:压线 壁厚:0.8mm 重量:0.127kg/m 长度:6m</p>	<p>型号:LBW063 名称:单吊轨(斜轮) 壁厚:2.3mm 重量:0.98kg/m 长度:6m</p>	<p>型号:LBW062 名称:双吊轨(斜轮) 壁厚:2.2mm 重量:1.61kg/m 长度:6m</p>	<p>型号:LBW062A 名称:吊轨盖板 壁厚:1.1mm 重量:0.228kg/m 长度:6m</p>
<p>颜色：黑珍珠</p> 	 <p>配套 LBW067</p>	<p>颜色：黑珍珠</p>  <p>配套 LBW033 LBW350</p>	<p>颜色：黑珍珠</p>  <p>配套 LBW033 LBW350</p>
<p>型号:LBW067 名称:三吊轨(斜轮) 壁厚:2.7mm 重量:2.82kg/m 长度:6m</p>	<p>型号:LBW067A 名称:三吊轨盖板 壁厚:1.2mm 重量:0.33kg/m 长度:6m</p>	<p>型号:LBW347 名称:单吊轨(凹轮) 壁厚:2.3mm 重量:0.937kg/m 长度:6m</p>	<p>型号:LBW348 名称:双吊轨(凹轮) 壁厚:2.3mm 重量:1.846kg/m 长度:6m</p>
<p>颜色：黑珍珠</p>  <p>配套 LBW347 LBW348</p>	 <p>配套 LBW031、LBW032 及极窄凹轮吊轨(不联动)</p>	 <p>配套 LBW259 LBW347 LBW253 LBW348 LBW142 LBW270 LBW143</p>	
<p>型号:LBW349 名称:吊轨拼条(凹轮) 壁厚:1.0mm 重量:0.246kg/m 长度:6m</p>	<p>型号:LBW033 名称:凹轮吊轨盖板 壁厚:1.0mm 重量:0.197kg/m 长度:6m</p>	<p>型号:LBW350 名称:凹轮联动吊轨盖板 壁厚:1.2mm 重量:0.281kg/m 长度:6m</p>	<p>型号:LBW095 名称:推拉收口(点锁) 壁厚:1.1mm 重量:0.39kg/m 长度:4.8m</p>
			
<p>型号:LBW176 名称:推拉收口(钩锁) 壁厚:1.1mm 重量:0.353kg/m 长度:4.8m</p>	<p>型号:LBW77A 名称:包套(前框) 壁厚:1.0mm 重量:0.489kg/m 长度:6.4m</p>	<p>型号:LBW079 名称:三分F槽 壁厚:1.0mm 重量:0.165kg/m 长度:6.2m</p>	<p>型号:LBW045 名称:三分P槽 壁厚:1.0mm 重量:0.170kg/m 长度:4.8m</p>



努力鸭  
奋斗啊!

现货颜色：玳瑁黑、玉瓷灰、月光灰、星空咖啡、珐琅白、威法金

其他颜色可订制!

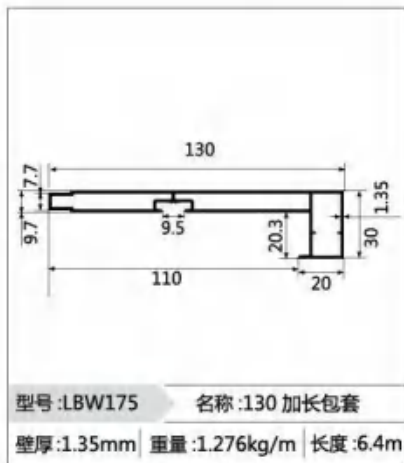
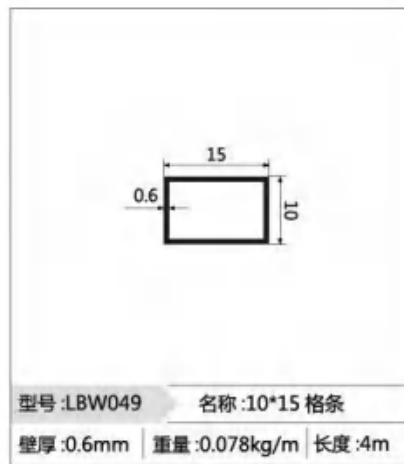
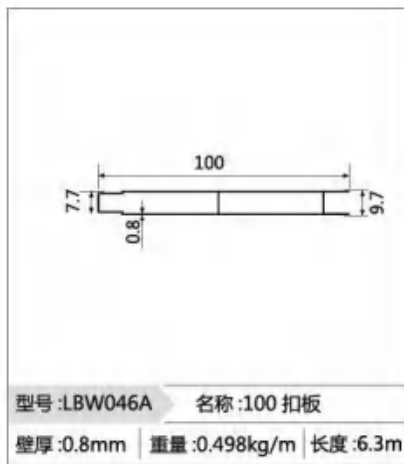
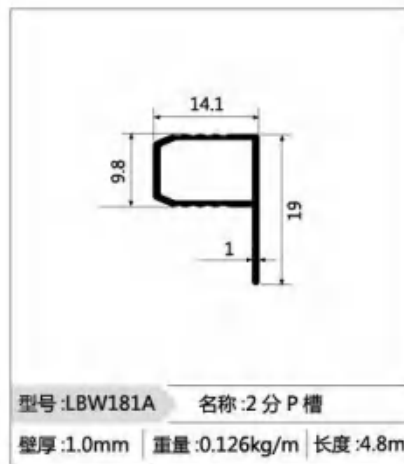
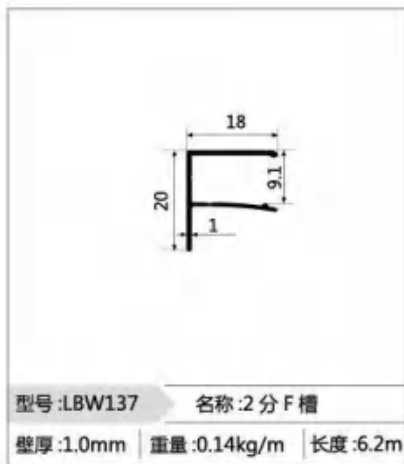
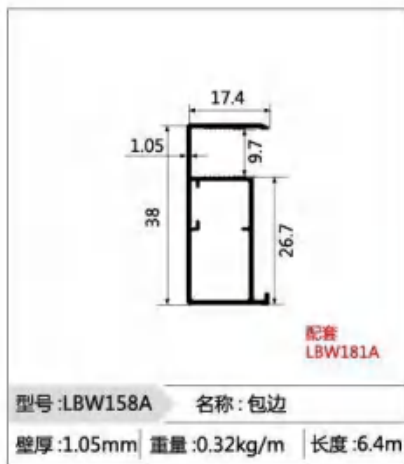
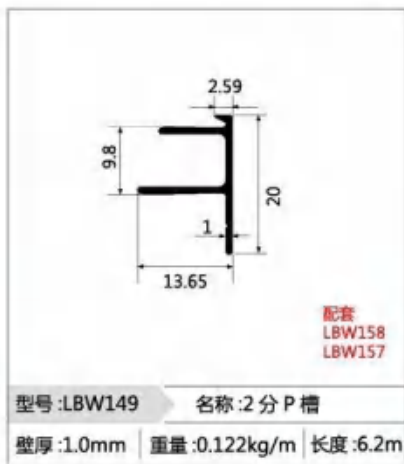
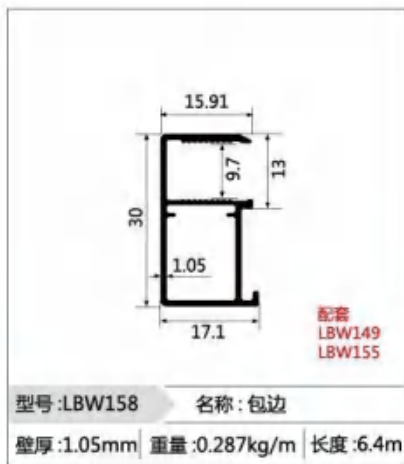

现货颜色：玳瑁黑、玉瓷灰、月光灰、星空咖啡、珐琅白、威法金  
其他颜色可订制!

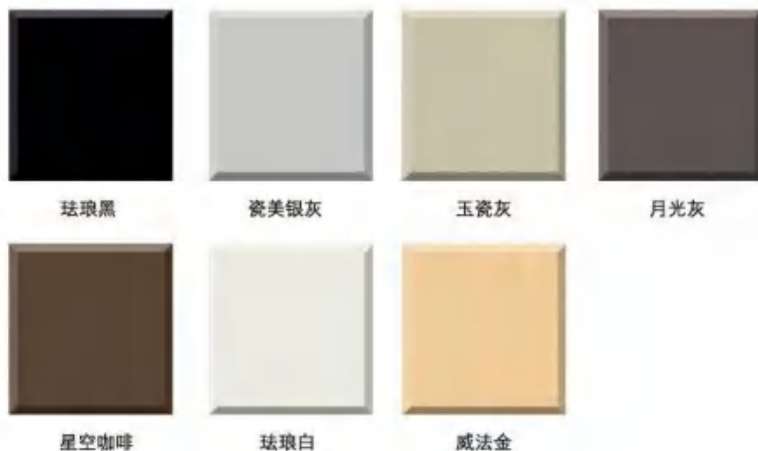



就是这样子装的

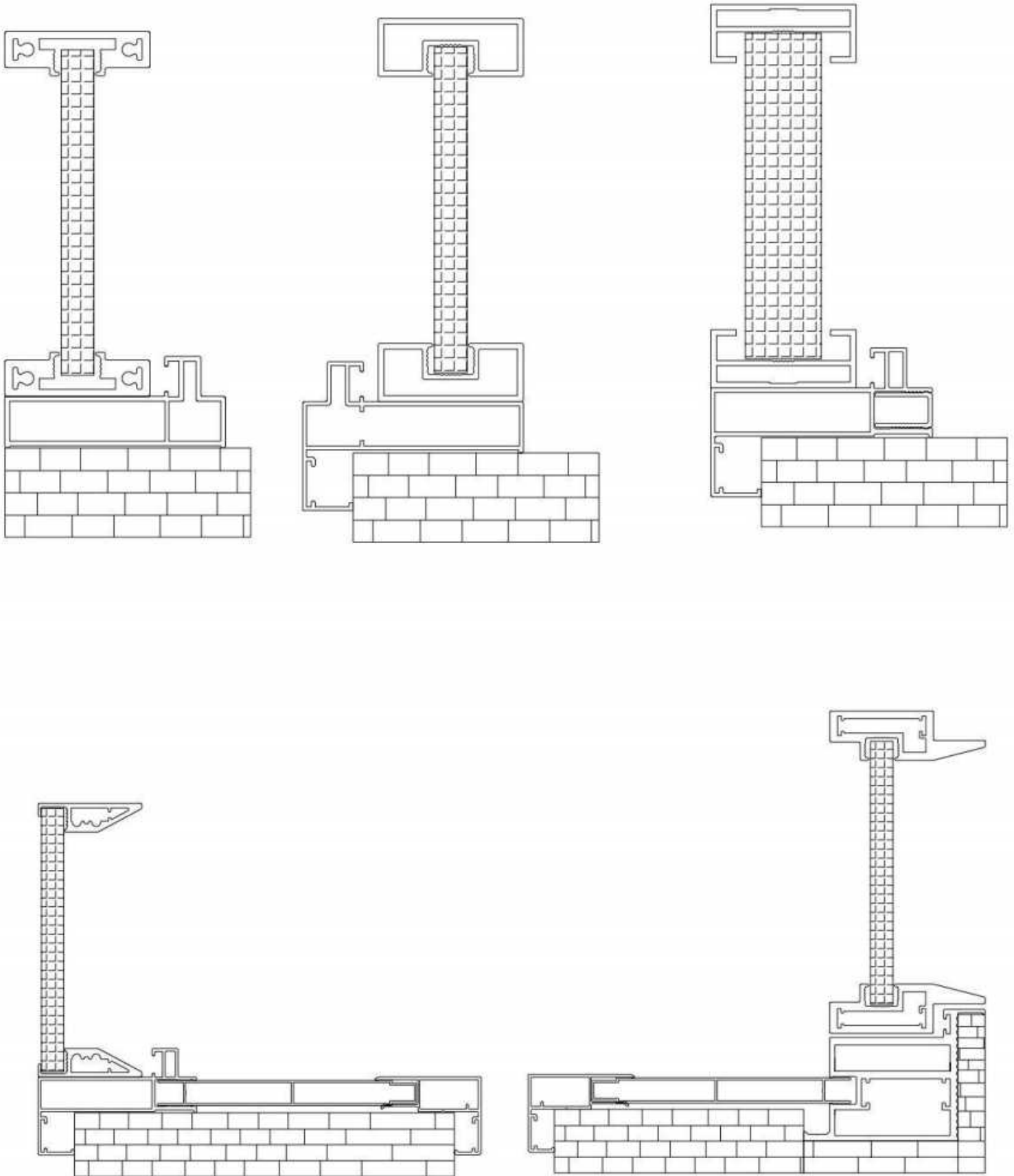

现货颜色：玳瑁黑、优雅白、月光灰、瓷美银灰、星空咖啡

其他颜色可订制!

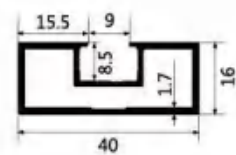
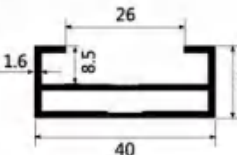
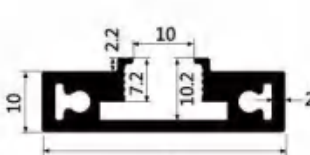
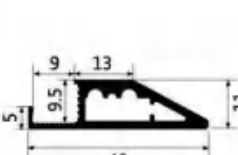
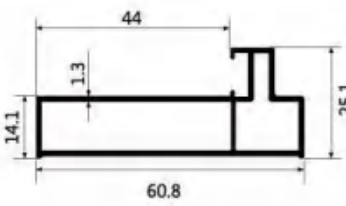
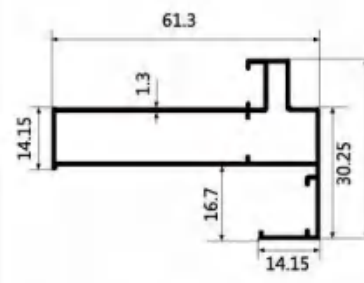
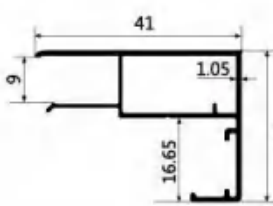
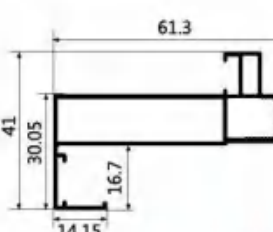
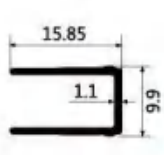
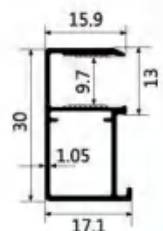
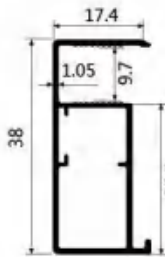
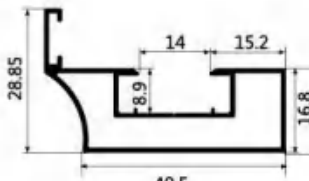
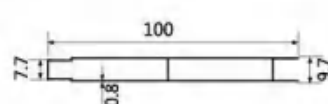
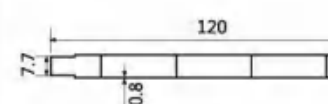
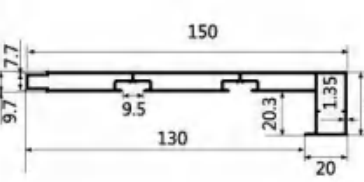
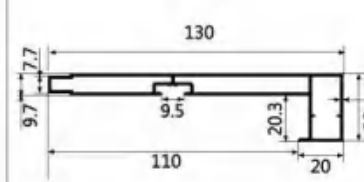

努力鸭 奋斗啊!

			
<p>型号:LBW260 名称:单玻光企</p> <p>壁厚:1.7mm 重量:0.509kg/m 长度:4.8m</p>	<p>型号:LBW290 名称:双玻光企</p> <p>壁厚:1.6mm 重量:0.481kg/m 长度:4.8m</p>	<p>型号:LBW354 名称:光企</p> <p>壁厚:2.2mm 重量:0.654kg/m 长度:4.8m</p>	<p>型号:LBW293 名称:微边光企</p> <p>壁厚:1.8mm 重量:0.425kg/m 长度:4.8m</p>
			 <p style="color:red">做反包配套 LBW154</p>
<p>型号:LBW274 名称:平墙外框</p> <p>壁厚:1.3mm 重量:0.645kg/m 长度:6.4m</p>	<p>型号:LBW275 名称:正包/外包</p> <p>壁厚:1.3mm 重量:0.695kg/m 长度:6.4m</p>	<p>型号:LBW292 名称:前框/包边</p> <p>壁厚:1.05mm 重量:0.361kg/m 长度:6.4m</p>	<p>型号:LBW273 名称:后框/反包</p> <p>壁厚:1.3mm 重量:0.684kg/m 长度:6.4m</p>
 <p style="color:red">做反包配套 LBW150A LBW151A LBW152A LBW153A LBW273</p>	 <p style="color:red">配套 LBW149 LBW155</p>	 <p style="color:red">配套 LBW181A</p>	
<p>型号:LBW154 名称:反包F槽</p> <p>壁厚:1.1mm 重量:0.113kg/m 长度:6.4m</p>	<p>型号:LBW158 名称:包边</p> <p>壁厚:1.05mm 重量:0.287kg/m 长度:6.4m</p>	<p>型号:LBW158A 名称:包边</p> <p>壁厚:1.05mm 重量:0.32kg/m 长度:6.4m</p>	<p>型号:LBW345 名称:平开门收口</p> <p>壁厚:1.0mm 重量:0.460kg/m 长度:4.8m</p>
			
<p>型号:LBW046A 名称:100扣板</p> <p>壁厚:0.8mm 重量:0.498kg/m 长度:6.3m</p>	<p>型号:LBW046B 名称:120扣板</p> <p>壁厚:0.8mm 重量:0.622kg/m 长度:6.3m</p>	<p>型号:LBW177 名称:150加长包套</p> <p>壁厚:1.35mm 重量:1.49kg/m 长度:6.4m</p>	<p>型号:LBW175 名称:130加长包套</p> <p>壁厚:1.35mm 重量:1.276kg/m 长度:6.4m</p>

现货颜色：玳瑁黑、优雅白、月光灰、瓷美银灰、星空咖啡

其他颜色可订制!



40 极窄平开门配件	
PK-01159(单玻平开锁-平面)	隐框平开门框胶条: JF-50151
PK-8656(双玻平开锁)	包边角码: JM-292 (配套 LBW292 使用)
PKS-293(微边平开锁)	包边角码: JM-158 (配套 LBW158/158A 使用)
PKS-278(隐框平开锁)	3.8 分包边组角片: ZJP-158A (9.2x1.0)
门扇角码: JM-260(4.3x36.5) 配套 LBW260/LBW290 使用	边封堵头: DT-163(配 2 分边封)
隐框门扇角码: JM-278(6x31) 配套 LBW278 使用	边封堵头: DT-61(配 3 分边封)
微边门扇角码: JM-293(4.7x14)	上下方堵头: DT-5754
4010 门扇角码: JM-354	外框组角片: ZJP-273275292(12.3x1.2)
外框角码: JM-273274275A (42.3x10.5)	一体套线角码: JM-175(9x12) 配套 LBW175/LBW177 使用
平开外框胶条: JT-273275	一体套线组角片: ZJP-175(14.8x75x2) 配套 LBW175/LBW177 使用



玳瑁黑



优雅白



月光灰



瓷美银灰



星空咖啡

## 40 老铁门中柱装饰条

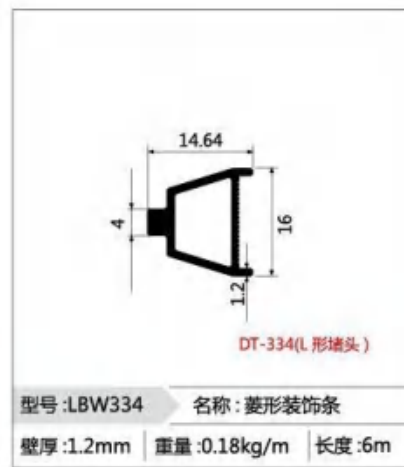

现货颜色：玳瑁黑、优雅白

其他颜色可订制!



玳瑁黑

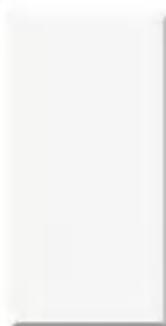

优雅白

啊。都别拦我



我这条命是用来工作的!

就是这样子装的

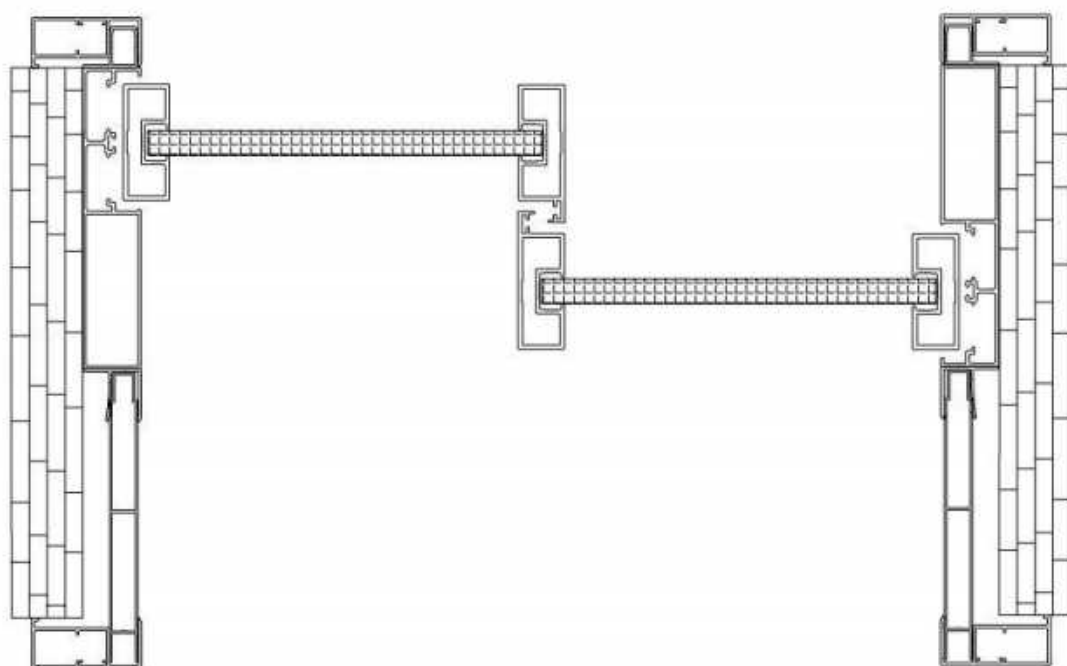
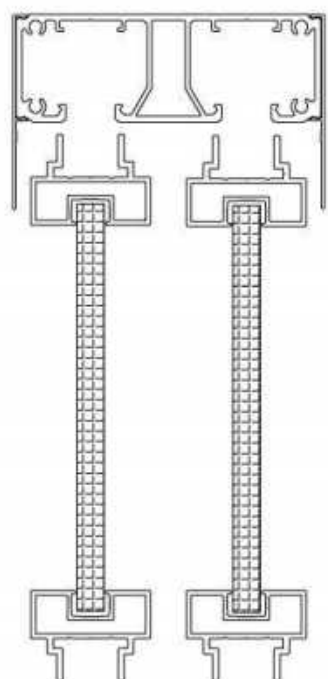
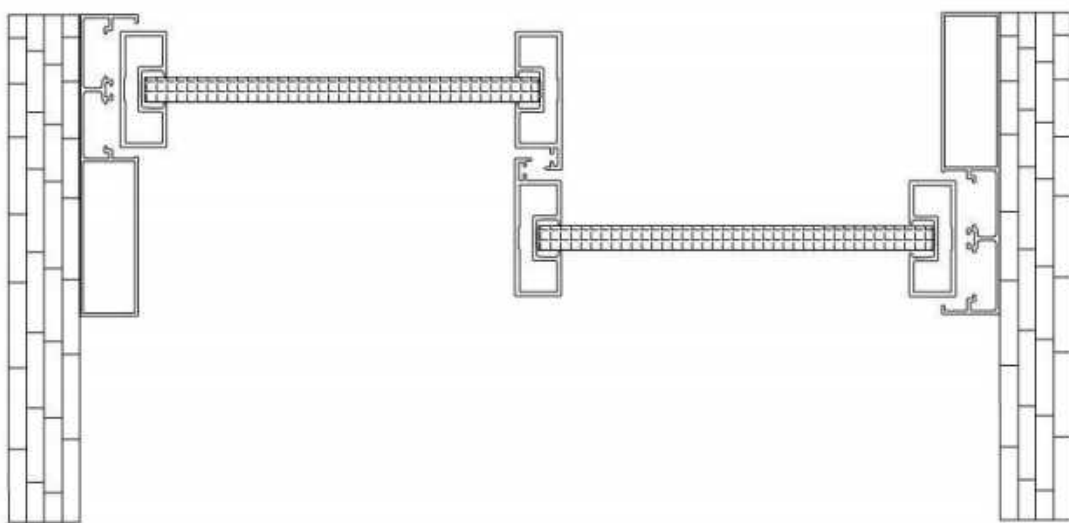
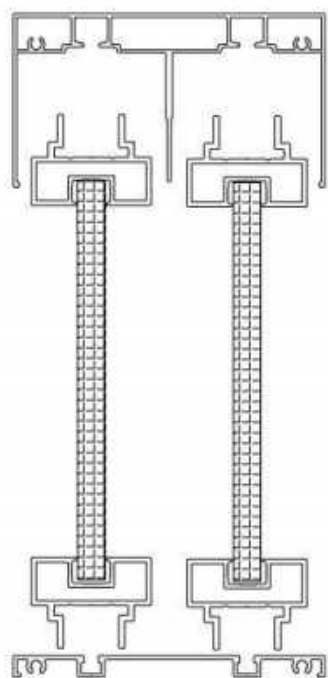



# 40 极窄推拉 / 吊趟门系列

高端系统门窗 - 定制极窄铝型材  
High-end system doors and windows - custom ultra-narrow aluminum profiles

现货颜色：珐琅黑、优雅白、月光灰、瓷美银灰、星空咖啡

其他颜色可订制!



努力鸭 奋斗啊!

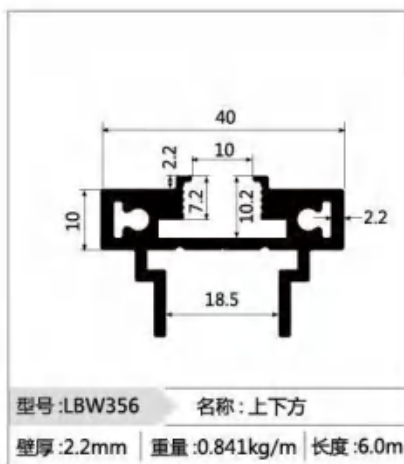
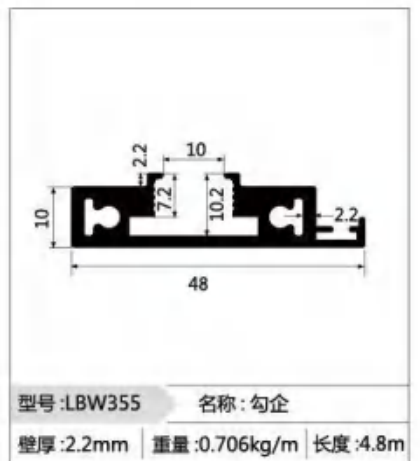
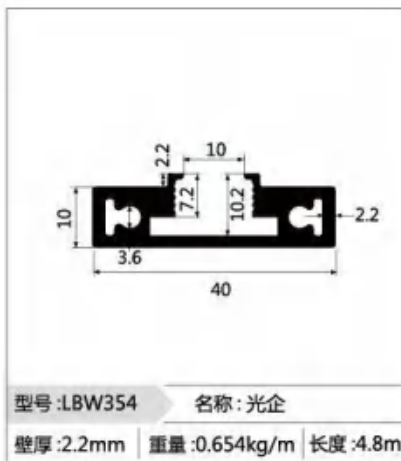
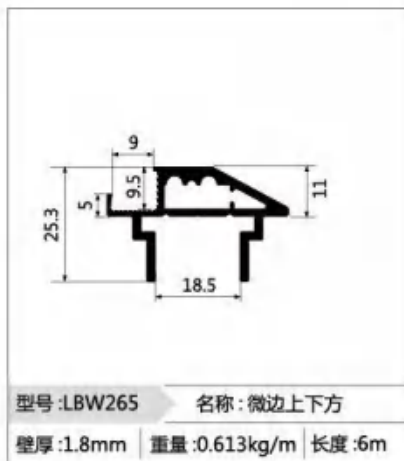
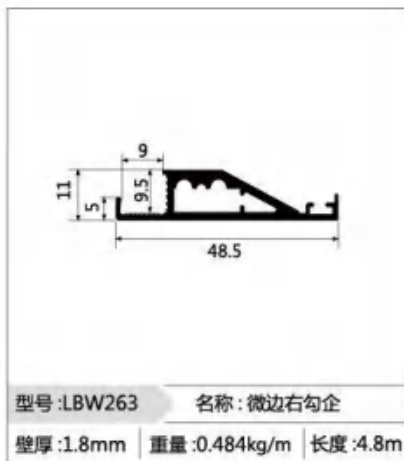
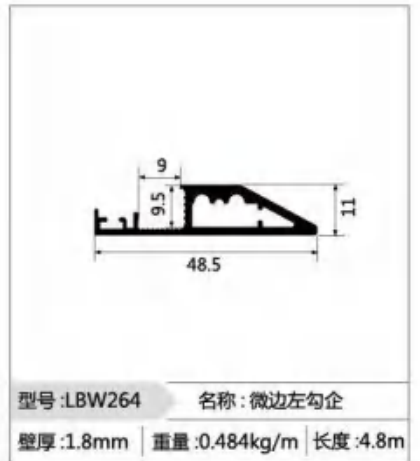
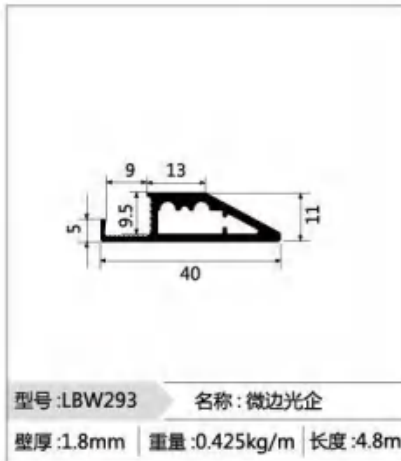
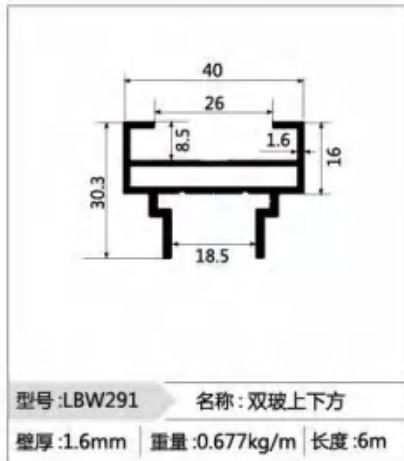
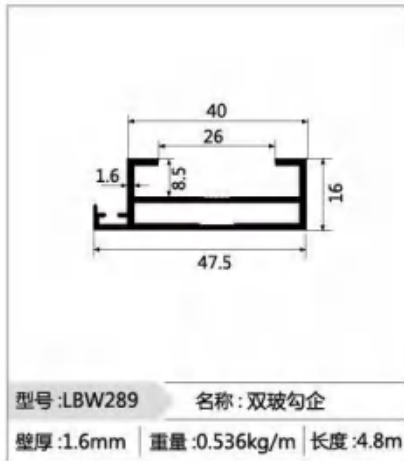
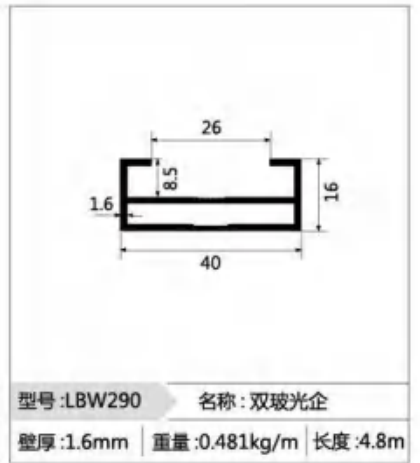
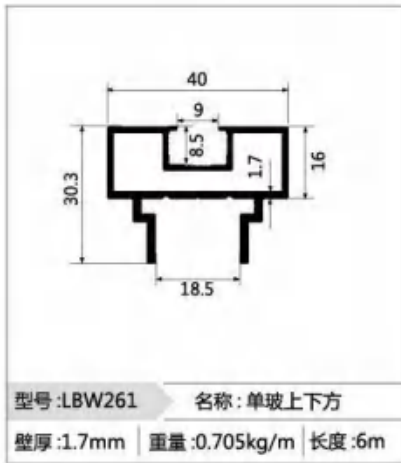
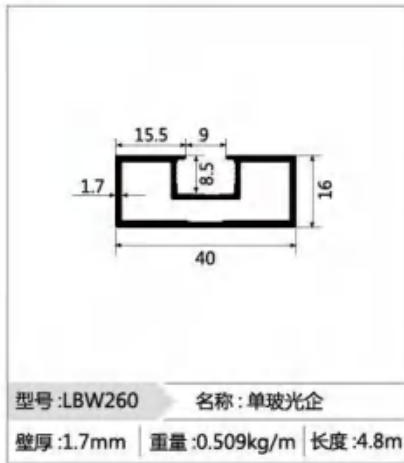

现货颜色：珐琅黑、优雅白、月光灰、瓷美银灰、星空咖啡

其他颜色可订制!



珐琅黑



优雅白



月光灰



瓷美银灰



星空咖啡



现货颜色：玳瑁黑、优雅白、月光灰、瓷泳银灰、星空咖啡  
其他颜色可订制！

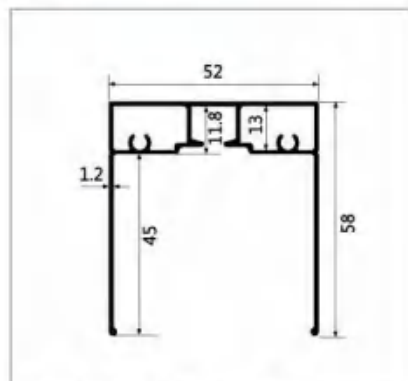

型号:LBW269 名称:单上轨  
壁厚:1.2mm 重量:0.782kg/m 长度:6m

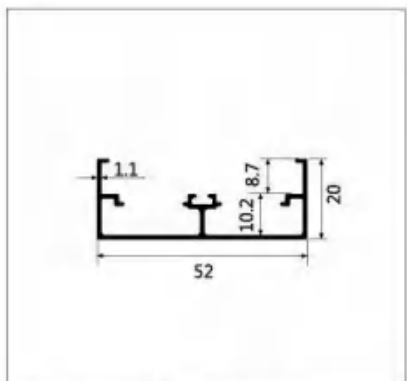

型号:LBW268 名称:单边封  
壁厚:1.1mm 重量:0.4kg/m 长度:4.8m

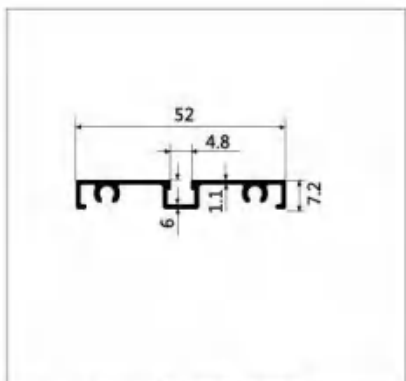

型号:LBW267 名称:单下轨  
壁厚:1.1mm 重量:0.34kg/m 长度:6m

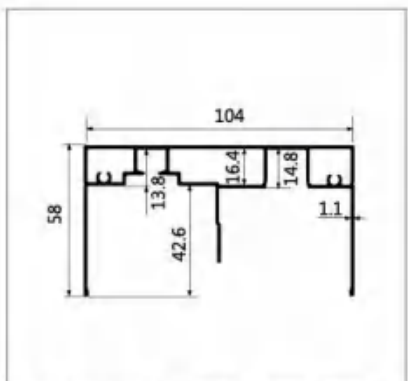

型号:LBW281 名称:2+0联动上轨  
壁厚:1.1mm 重量:1.291kg/m 长度:6m

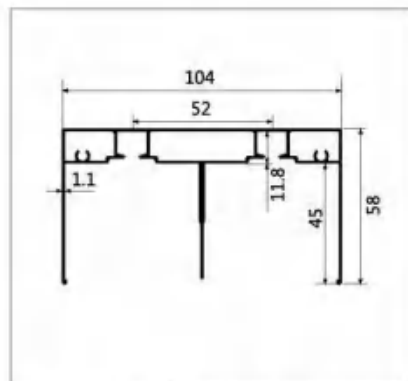

型号:LBW258 名称:推拉双上轨  
壁厚:1.1mm 重量:1.326kg/m 长度:6m

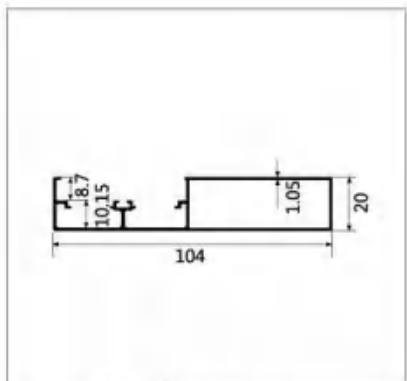

型号:LBW257 名称:双边封  
壁厚:1.05mm 重量:0.759kg/m 长度:4.8m

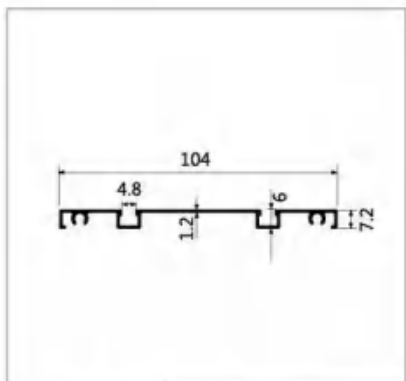

型号:LBW295 名称:双下轨  
壁厚:1.2mm 重量:0.575kg/m 长度:6m

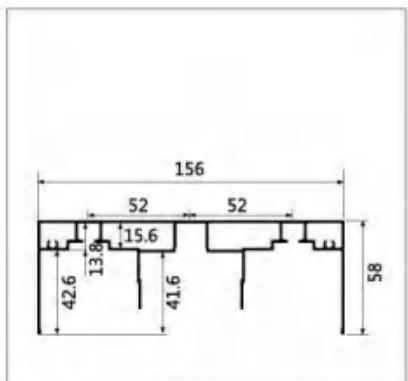

型号:LBW271 名称:推拉三联动上轨  
壁厚:1.3mm 重量:2.015kg/m 长度:6m

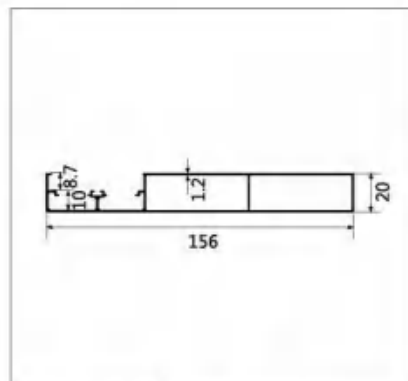

型号:LBW294 名称:三边封  
壁厚:1.2mm 重量:1.225kg/m 长度:5.2m

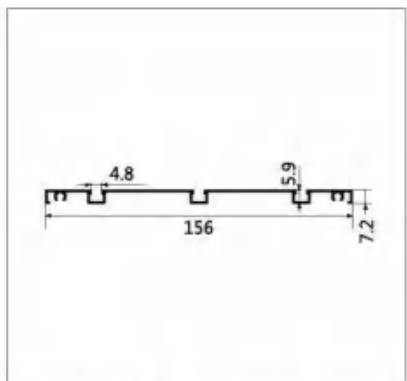

型号:LBW272 名称:三下轨  
壁厚:1.3mm 重量:0.851kg/m 长度:6m



型号:LBW270 名称:单吊轨(凹轮)  
壁厚:1.9mm 重量:1.025kg/m 长度:6m



型号:LBW259 名称:双吊轨(凹轮)  
壁厚:2.0mm 重量:1.905kg/m 长度:6m

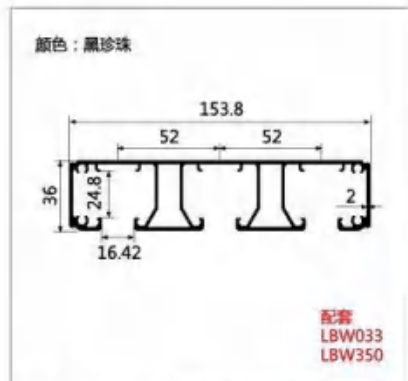

型号:LBW353 名称:三吊轨(凹轮)  
壁厚:2.0mm 重量:2.756kg/m 长度:6m



型号:LBW279 名称:40/50凹轮吊轨拼条  
壁厚:1.2mm 重量:0.158kg/m 长度:6m

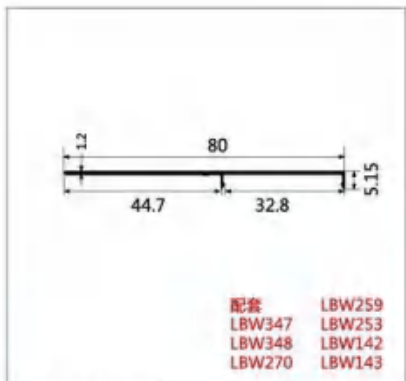

型号:LBW350 名称:凹轮联动吊轨盖板  
壁厚:1.2mm 重量:0.281kg/m 长度:6m



型号:LBW033 名称:凹轮吊轨盖板  
壁厚:1.0mm 重量:0.197kg/m 长度:6m

# 40 极窄推拉 / 吊趟门系列

高端系统门窗 - 定制极窄铝型材  
High-end system doors and windows - custom narrow aluminum profiles

现货颜色：玳瑁黑、优雅白、月光灰、瓷泳银灰、星空咖啡  
其他颜色可订制!



努力鸭 奋斗啊!

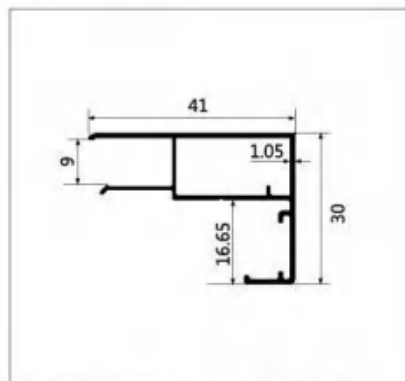

型号:LBW292 名称:前框/包边  
壁厚:1.05mm 重量:0.361kg/m 长度:6.4m

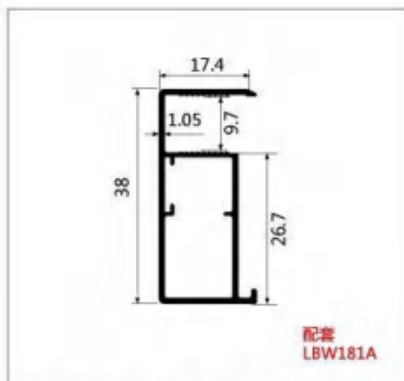

型号:LBW158A 名称:包边  
壁厚:1.05mm 重量:0.32kg/m 长度:6.4m

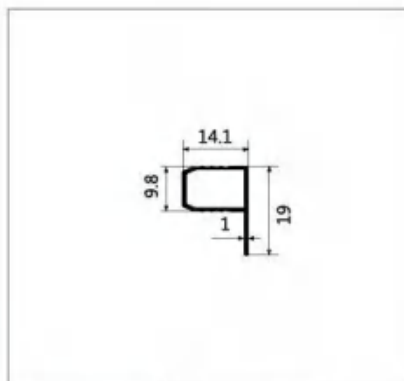

型号:LBW181A 名称:2分P槽  
壁厚:1.0mm 重量:0.126kg/m 长度:4.8m

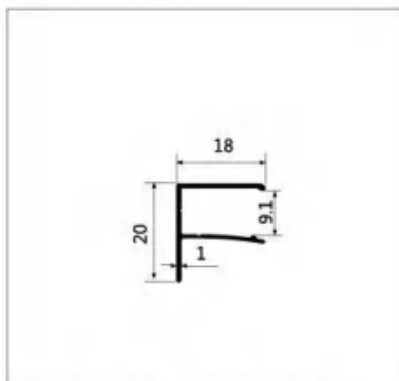

型号:LBW137 名称:2分F槽  
壁厚:1.0mm 重量:0.14kg/m 长度:6.2m

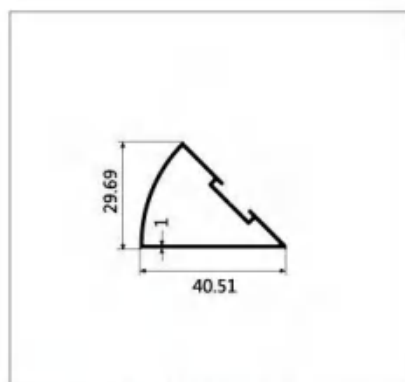

型号:LBW352 名称:转角  
壁厚:1.0mm 重量:0.328kg/m 长度:4.8m

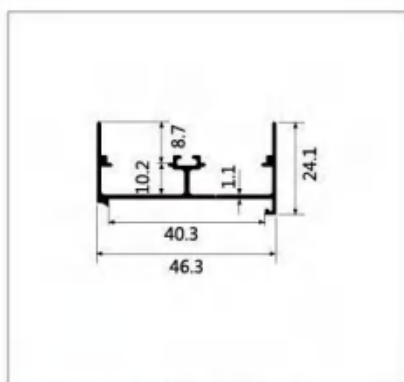

型号:LBW266 名称:推拉收口  
壁厚:1.1mm 重量:0.386kg/m 长度:4.8m

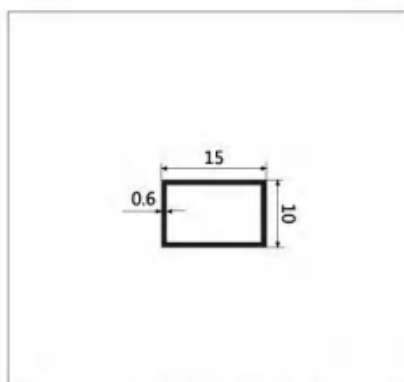

型号:LBW049 名称:10\*15格条  
壁厚:0.6mm 重量:0.078kg/m 长度:4m

## 40 极窄推拉门配件

40 单玻连体拉手: LS-260(配套铝材颜色)	3.8分包边组角片: ZJP-158A (9.2x1.0)
40 单玻连体拉手锁: LSS-260(配套铝材颜色)	上轮: SL-01
40 双玻连体拉手: LS-290(配套铝材颜色)	下轮: XL-01-2(两轮), XL-01-4(四轮)
40 双玻连体拉手锁: LSS-290(配套铝材颜色)	勾企边密封胶条: JF-4058262(3.8)
门扇角码: JM-260(4.3x36.5) 配套LBW260/LBW290使用	边封堵头: DT-257
隐框门扇角码: JM-278(6x31) 配套LBW278使用	上下方堵头: DT-261
微边门扇角码: JM-293(4.7x14)	锁槽压条: KT-01(边封卡条)
4010 门扇角码: JM-354	

现货颜色：玳瑁黑、优雅白、月光灰、瓷美银灰、星空咖啡  
其他颜色可订制!



玳瑁黑



优雅白



月光灰



瓷美银灰



星空咖啡

就是这样子装的

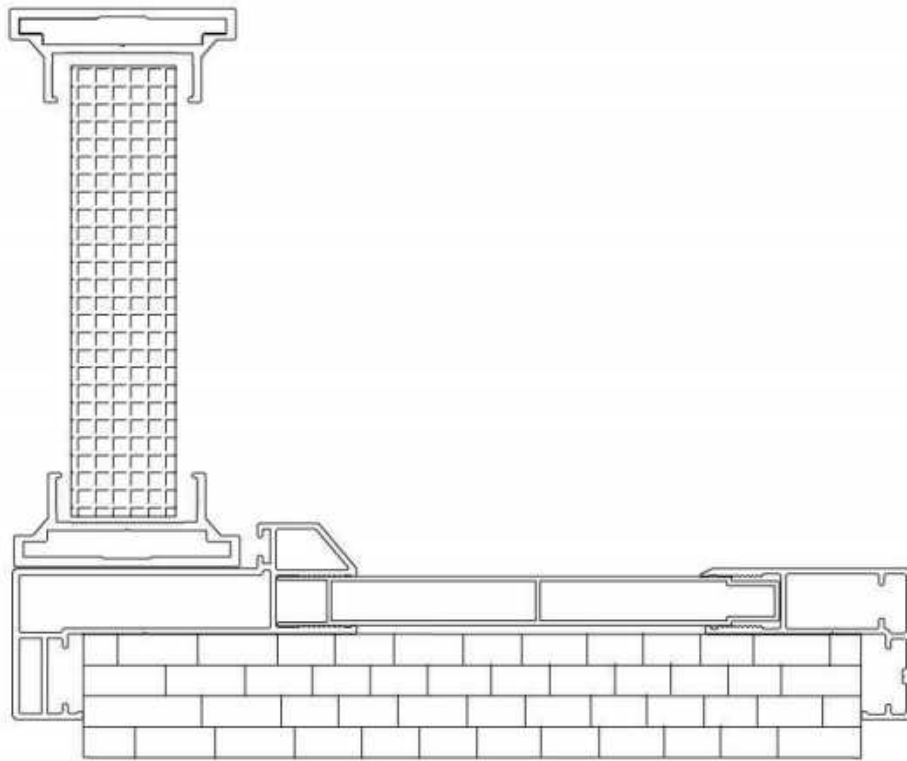
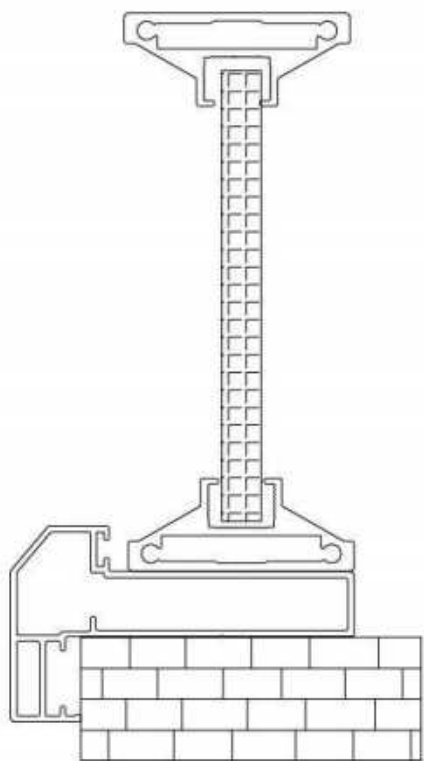
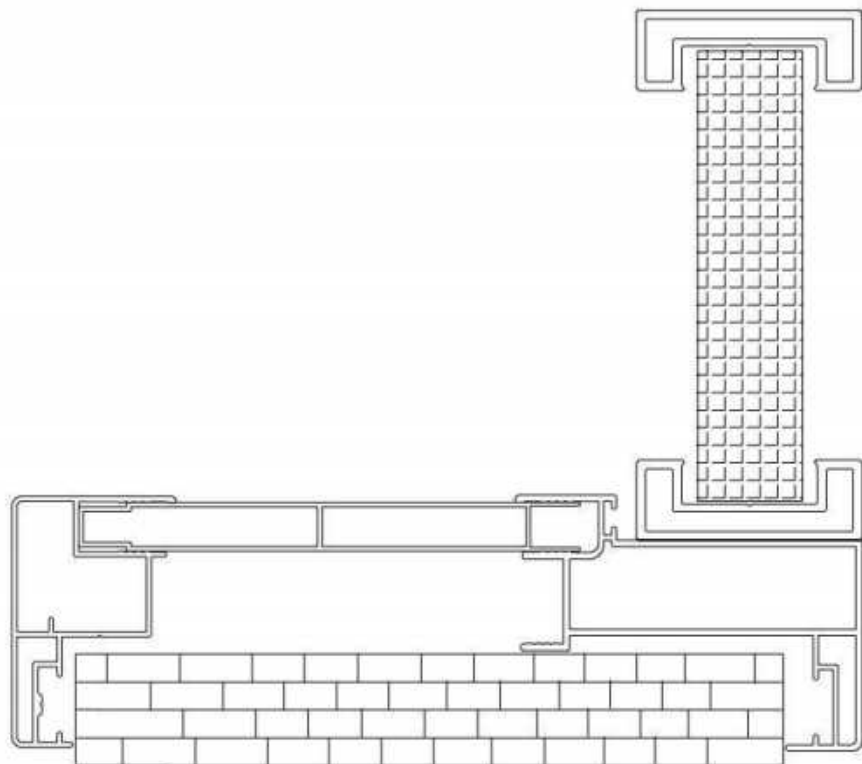
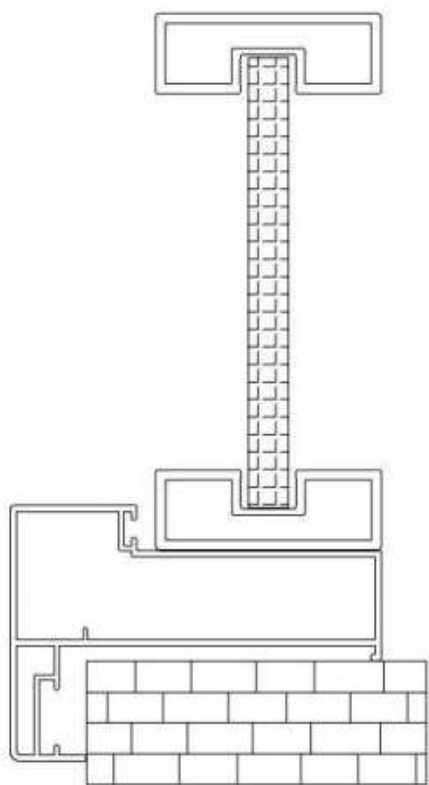



# 45 极窄平开门系列

高端系统门窗 - 定制极窄铝型材  
High-end system doors and windows - custom ultra-thin aluminum profiles

现货颜色：玳瑁黑、玳瑁白、威法金、月光灰、玉瓷灰、星空咖啡  
其他颜色可订制!

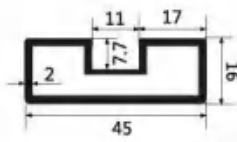
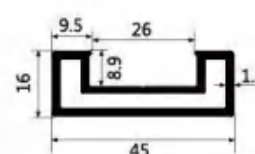
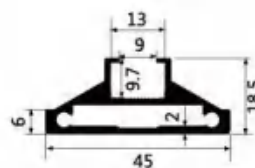
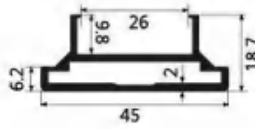
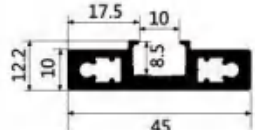
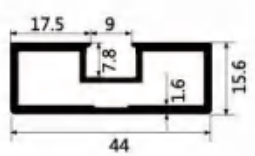
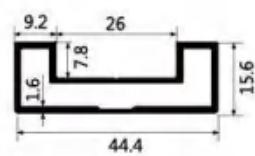
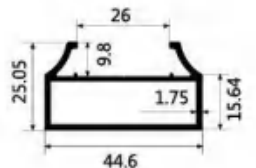
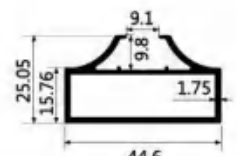
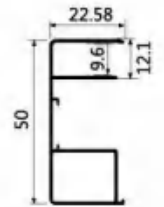
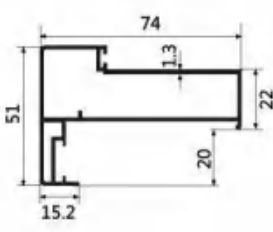
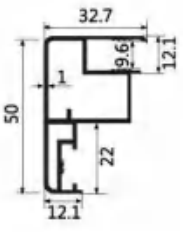
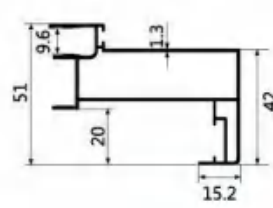
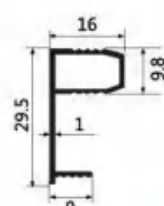
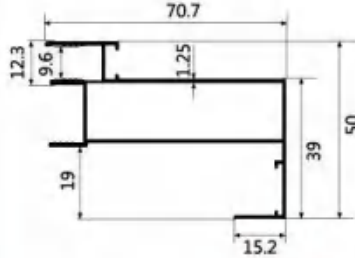
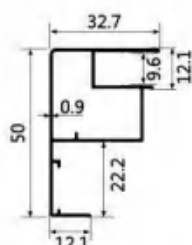

努力  
奋斗啊!

			
<p>型号:LBW001 名称:单玻光企 壁厚:2.0mm 重量:0.668kg/m 长度:4.8m</p>	<p>型号:LBW086 名称:双玻光企 壁厚:2.0mm 重量:0.6kg/m 长度:4.8m</p>	<p>型号:LBW010 名称:单玻光企 壁厚:2.0mm 重量:0.672kg/m 长度:4.8m</p>	<p>型号:LBW014 名称:双玻光企 壁厚:2.0mm 重量:0.563kg/m 长度:4.8m</p>
			
<p>型号:LBW120 名称:单玻光企 壁厚:10mm 重量:0.788kg/m 长度:4.8m</p>	<p>型号:LBW296 名称:单玻光企 壁厚:1.6mm 重量:0.557kg/m 长度:4.8m</p>	<p>型号:LBW299 名称:双玻光企 壁厚:1.6mm 重量:0.514kg/m 长度:4.8m</p>	<p>型号:LBW167 名称:双玻光企 壁厚:1.75mm 重量:0.634kg/m 长度:4.8m</p>
			
<p>型号:LBW170 名称:单玻光企 壁厚:1.75mm 重量:0.668kg/m 长度:4.8m</p>	<p>型号:LBW114 名称:包边 壁厚:1.0mm 重量:0.416kg/m 长度:6.4m</p>	<p>型号:LBW050 名称:正包 壁厚:1.3mm 重量:0.91kg/m 长度:6.4m</p>	<p>型号:LBW044 名称:包套/前框 壁厚:1.0mm 重量:0.54kg/m 长度:6.4m</p>
 <p style="color: red;">做反包配套 LBW052</p>	 <p style="color: red;">配套 LBW051 LBW302</p>	 <p style="color: red;">做反包配套 LBW052</p>	
<p>型号:LBW051 名称:反包/后框 壁厚:1.3mm 重量:0.89kg/m 长度:6.4m</p>	<p>型号:LBW052 名称:反包F槽 壁厚:1.0mm 重量:0.19kg/m 长度:6.4m</p>	<p>型号:LBW302 名称:反包/后框 壁厚:1.25mm 重量:0.761kg/m 长度:6.4m</p>	<p>型号:LBW304 名称:包套 壁厚:0.9mm 重量:0.434kg/m 长度:6.4m</p>

现货颜色：玳瑁黑、玳瑁白、威法金、月光灰、玉瓷灰、星空咖啡

其他颜色可订制!

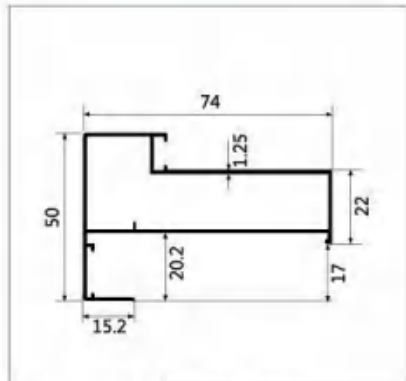

型号:LBW303 名称:正包框  
壁厚:1.25mm 重量:0.768kg/m 长度:6.4m

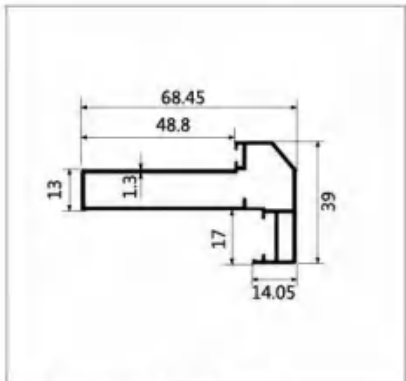

型号:LBW150A 名称:正包  
壁厚:1.3mm 重量:0.75kg/m 长度:6.4m

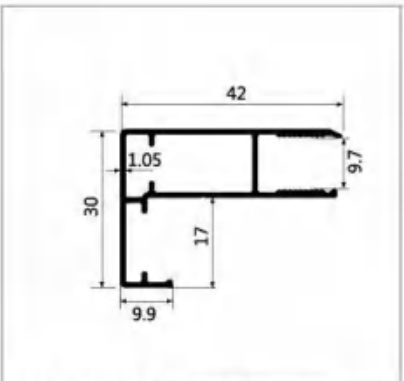

型号:LBW157 名称:前框/包套  
壁厚:1.05mm 重量:0.436kg/m 长度:6.4m

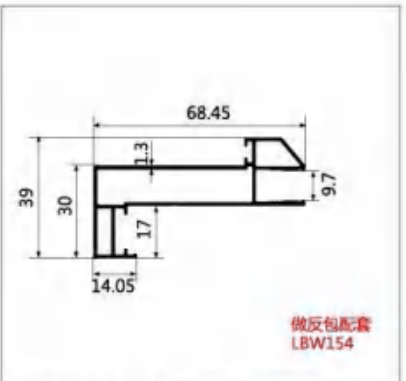

型号:LBW151A 名称:后包框  
壁厚:1.3mm 重量:0.801kg/m 长度:6.4m

做反包配套  
LBW154

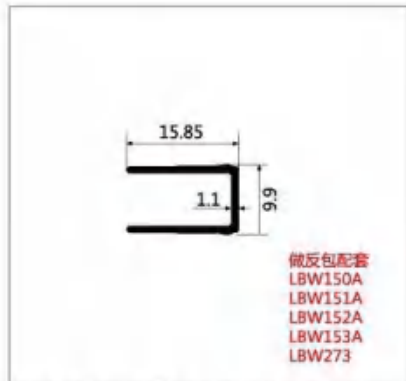

型号:LBW154 名称:反包 F 槽  
壁厚:1.1mm 重量:0.113kg/m 长度:6.4m

做反包配套  
LBW150A  
LBW151A  
LBW152A  
LBW153A  
LBW273

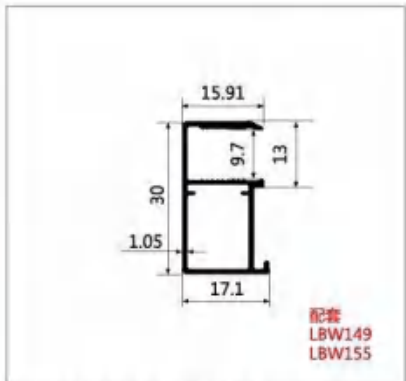

型号:LBW158 名称:包边  
壁厚:1.05mm 重量:0.287kg/m 长度:6.4m

配套  
LBW149  
LBW155

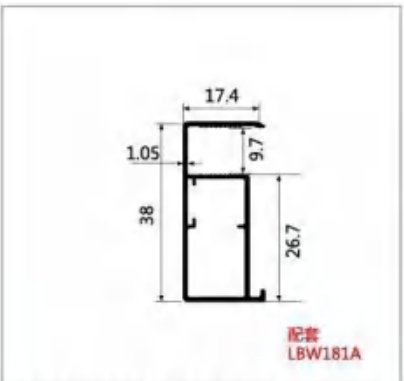

型号:LBW158A 名称:包边  
壁厚:1.05mm 重量:0.32kg/m 长度:6.4m

配套  
LBW181A

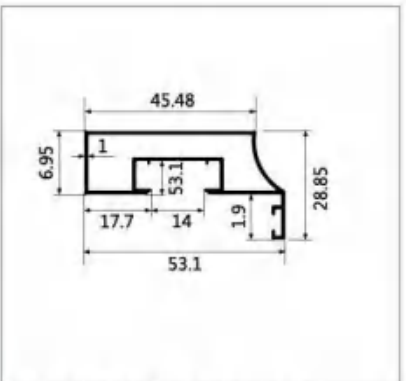

型号:LBW098 名称:平开收口  
壁厚:1.0mm 重量:0.496kg/m 长度:4.8m

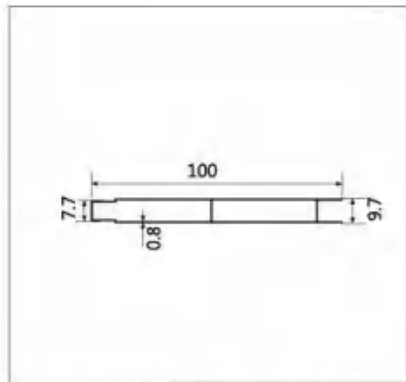

型号:LBW046A 名称:100 扣板  
壁厚:0.8mm 重量:0.498kg/m 长度:6.3m

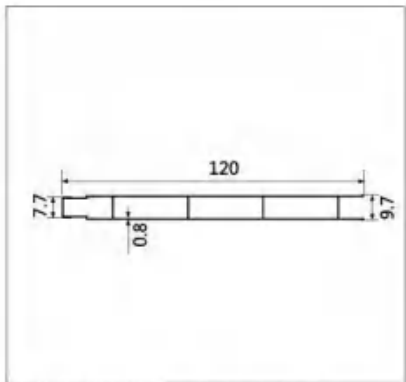

型号:LBW046B 名称:120 扣板  
壁厚:0.8mm 重量:0.622kg/m 长度:6.3m

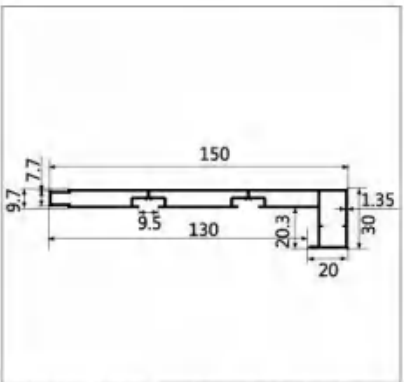

型号:LBW177 名称:150 加长包套  
壁厚:1.35mm 重量:1.49kg/m 长度:6.4m

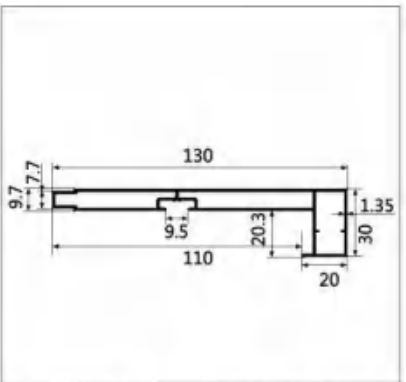

型号:LBW175 名称:130 加长包套  
壁厚:1.35mm 重量:1.276kg/m 长度:6.4m

### 45 极窄平开门配件

门扇角码:	JM-01-1(40.6x4.5)( 配套 LBW001/002/003/296/297/298/299/300/301 使用 )
	JM-86-1(40.6x3.5)( 配套 LBW086/LBW088/LBW089 使用 )
	JM-0635(31.3x4.5)( 配套 LBW010/LBW011/LBW012/LBW013/LBW015/LBW016 使用 )
	JM-167( 微缝平开门扇角码 )
	JM-51-1 45 平开后框角码 ( 49.6*15.5 )
	JM-50-1 45 平开外框角码 ( 56.5*15.5 )
	JM-199244245.44 前框角码 ( 14*18 )
	JM-150-1 45 超窄平开外框角码 ( 49.5*10 )
	JM-157 前框角码 ( 18*10.5 )
	平开单玻锁: PK-01159( 配套铝材颜色 )
平开双玻锁: PK-8656( 配套铝材颜色 )	

现货颜色：玳瑁黑、玳瑁白、威法金、月光灰、玉瓷灰、星空咖啡

其他颜色可订制!



玳瑁黑



瓷美银灰



玳瑁白



威法金



月光灰



玉瓷灰



星空咖啡

就是这样子装的

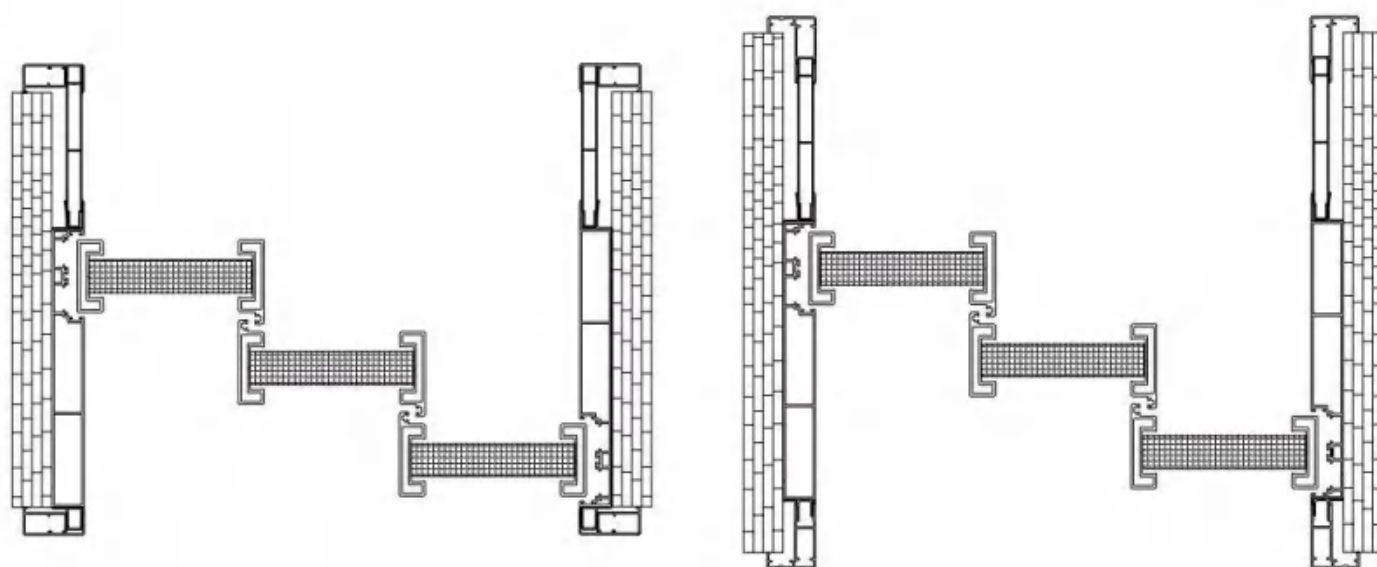
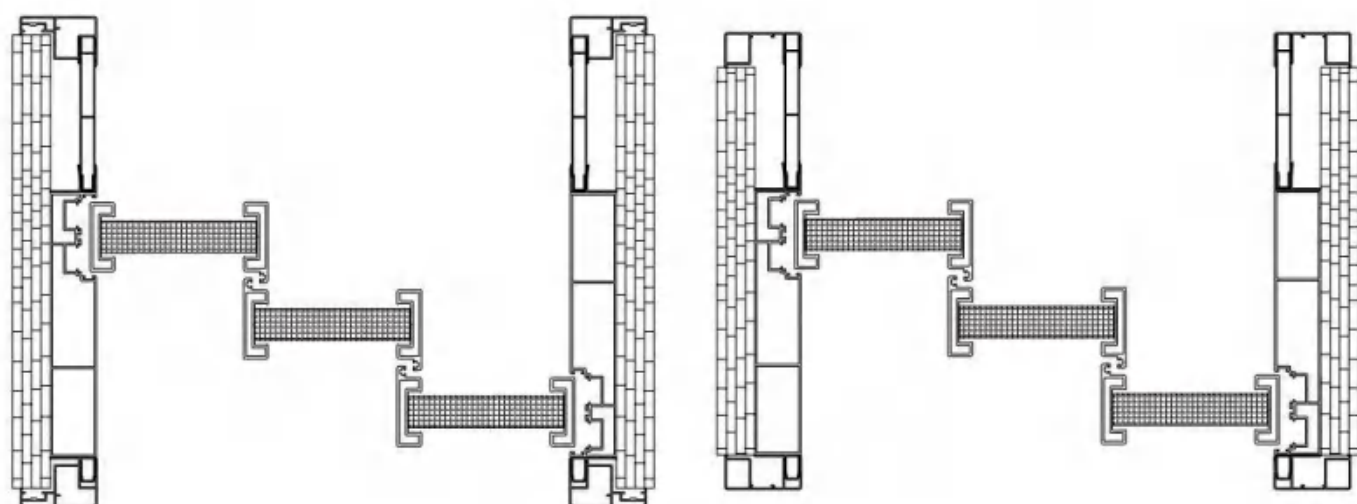
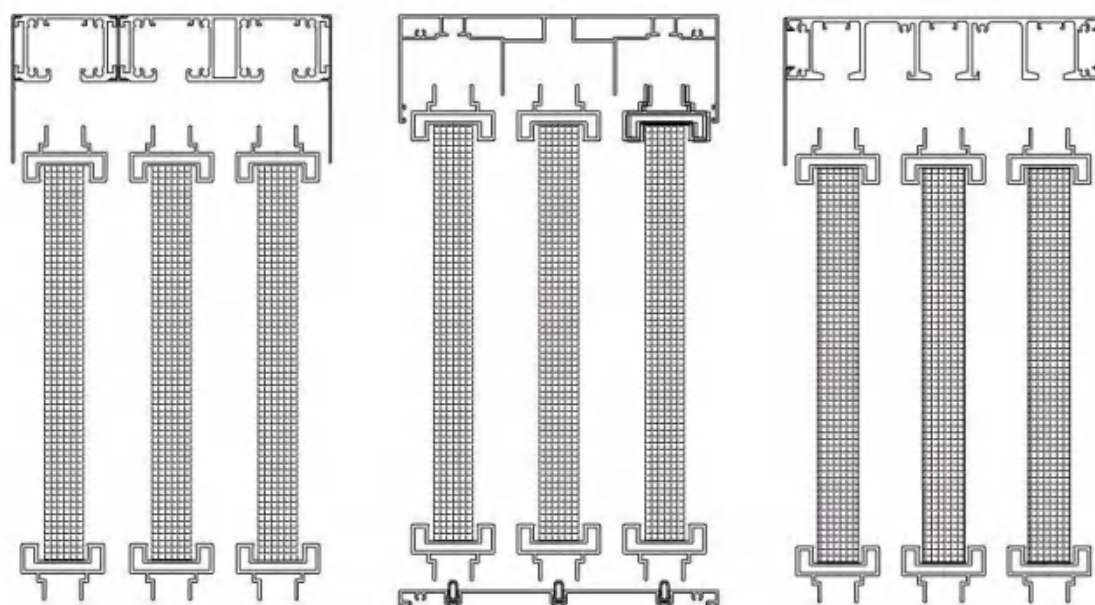





现货颜色：珐琅黑、珐琅白、威法金、月光灰、玉瓷灰、星空咖啡、瓷美银灰  
其他颜色可订制!



努力鸭 奋斗鸭!

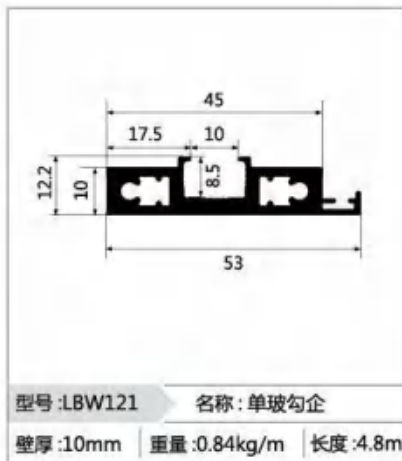
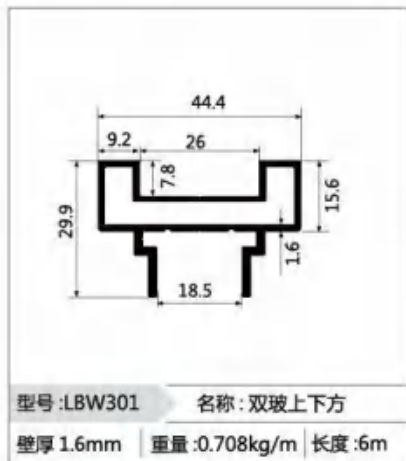
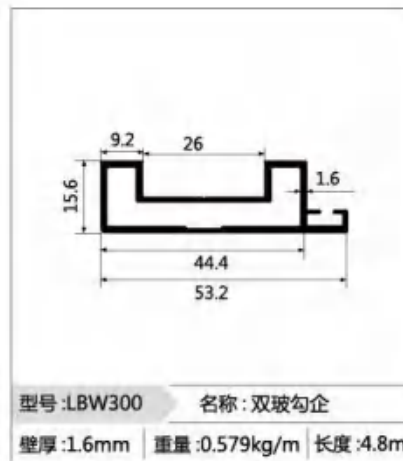
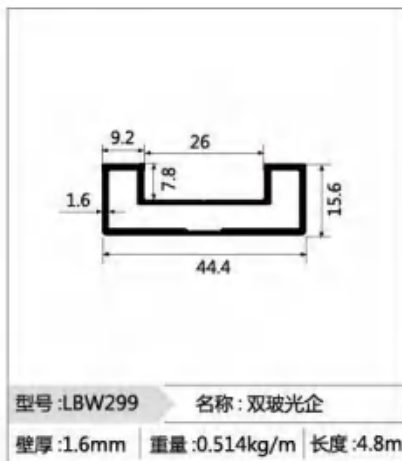
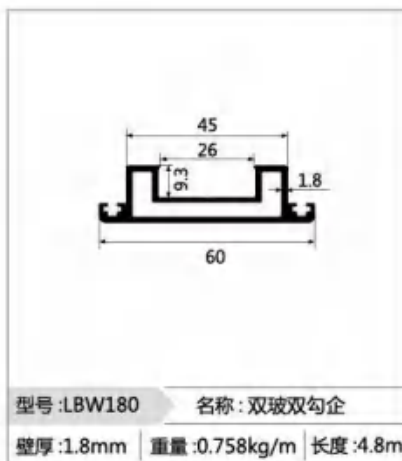
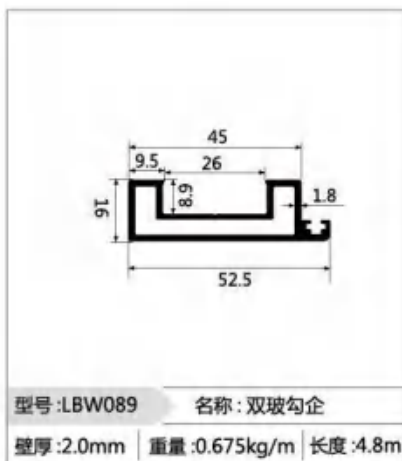
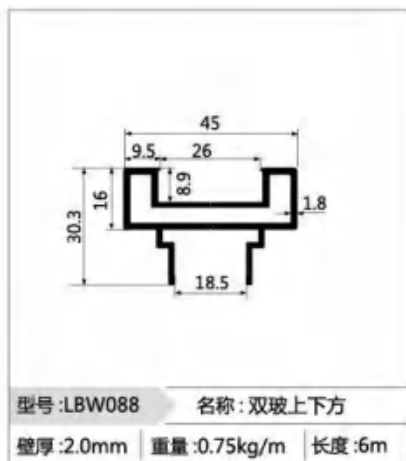
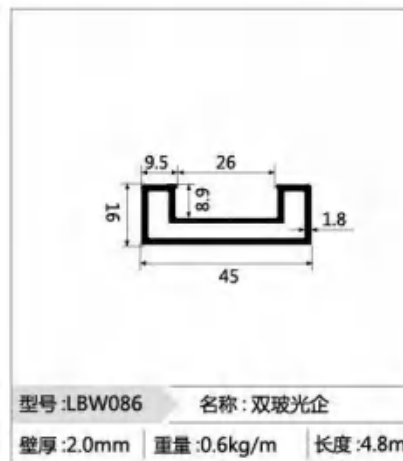
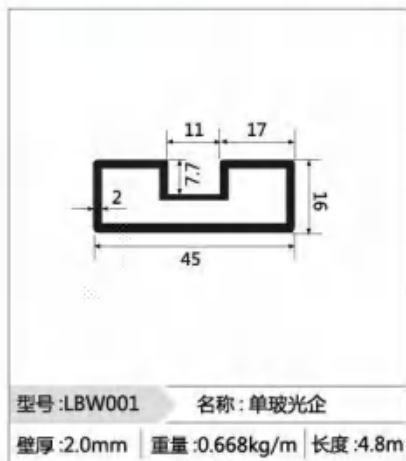



# 45 极窄推拉 / 吊趟门系列

高端系统门窗 - 定制极窄铝型材  
High-end system doors and windows - custom ultra-narrow aluminum profiles

现货颜色：玳瑁黑、玳瑁白、威法金、月光灰、玉瓷灰、星空咖啡  
其他颜色可订制!

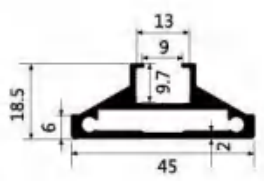
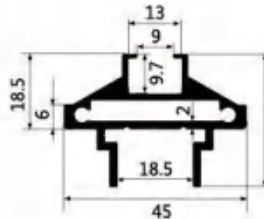
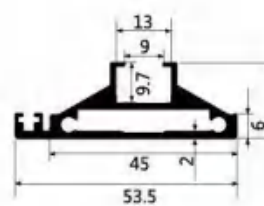
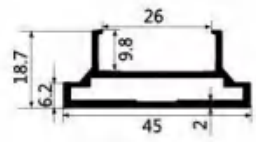
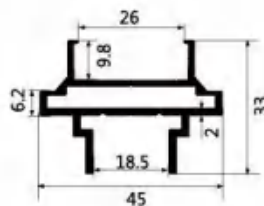
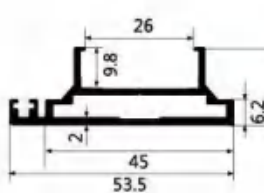
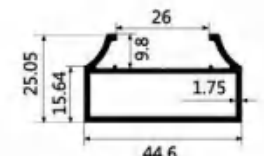
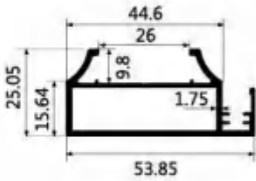
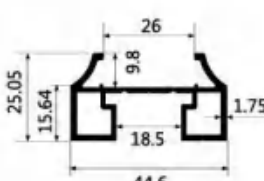
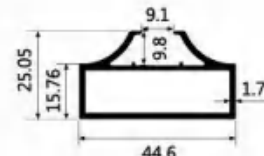
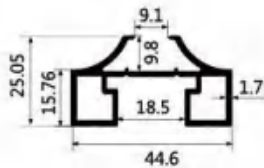
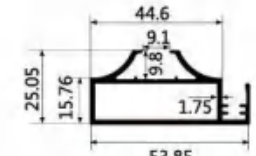
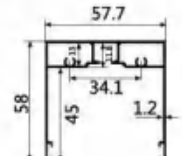
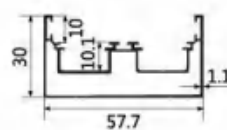
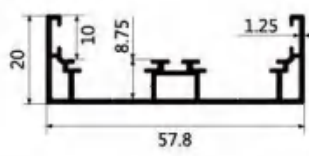
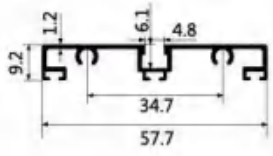

努力  
奋斗啊!

			
<p>型号:LBW10 名称:单玻光企 壁厚:2.0mm 重量:0.672kg/m 长度:4.8m</p>	<p>型号:LBW011 名称:单玻上下方 壁厚:2.0mm 重量:0.870kg/m 长度:6m</p>	<p>型号:LBW012 名称:单玻勾企 壁厚:2.0mm 重量:0.760kg/m 长度:4.8m</p>	<p>型号:LBW014 名称:双玻光企 壁厚:2.0mm 重量:0.563kg/m 长度:4.8m</p>
			
<p>型号:LBW015 名称:双玻上下方 壁厚:2.0mm 重量:0.767kg/m 长度:6m</p>	<p>型号:LBW013 名称:双玻勾企 壁厚:2.0mm 重量:0.658kg/m 长度:4.8m</p>	<p>型号:LBW167 名称:双玻光企 壁厚:1.75mm 重量:0.634kg/m 长度:4.8m</p>	<p>型号:LBW168 名称:双玻勾企 壁厚:1.75mm 重量:0.744kg/m 长度:4.8m</p>
			
<p>型号:LBW169 名称:双玻上下方 壁厚:1.75mm 重量:0.676kg/m 长度:6m</p>	<p>型号:LBW170 名称:单玻光企 壁厚:1.75mm 重量:0.668kg/m 长度:4.8m</p>	<p>型号:LBW171 名称:单玻勾企 壁厚:1.75mm 重量:0.71kg/m 长度:4.8m</p>	<p>型号:LBW172 名称:单玻上下方 壁厚:1.75mm 重量:0.778kg/m 长度:6m</p>
			
<p>型号:LBW026 名称:推拉单上轨 壁厚:1.2mm 重量:0.842kg/m 长度:6m</p>	<p>型号:LBW039 名称:单边封 壁厚:1.1mm 重量:0.71kg/m 长度:4.8m</p>	<p>型号:LBW132 名称:单边封 壁厚:1.25mm 重量:0.567kg/m 长度:4.8m</p>	<p>型号:LBW134 名称:单下轨 壁厚:1.2mm 重量:0.405kg/m 长度:6m</p>

现货颜色：玳瑁黑、玳瑁白、威法金、月光灰、玉瓷灰、星空咖啡

其他颜色可订制!

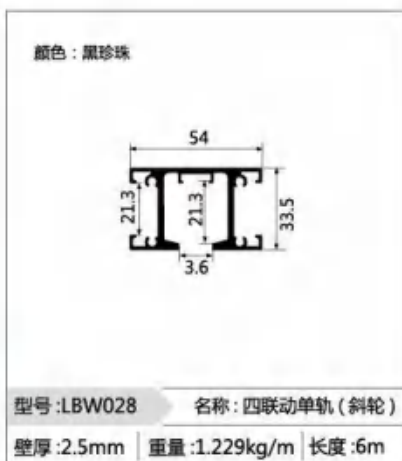
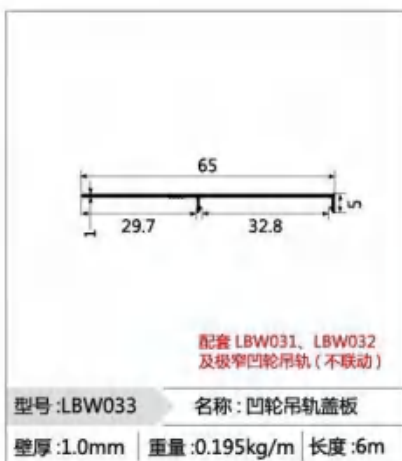
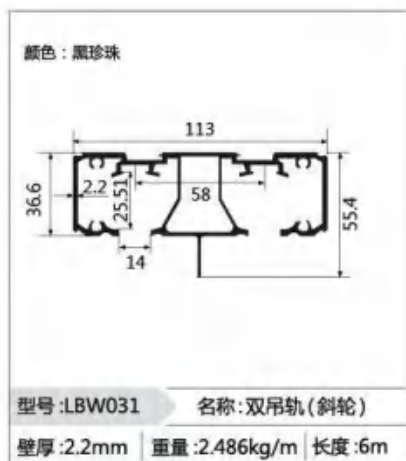
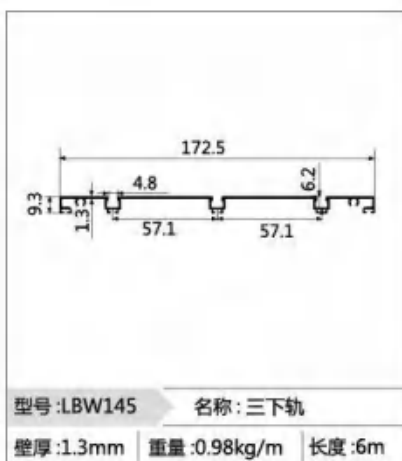
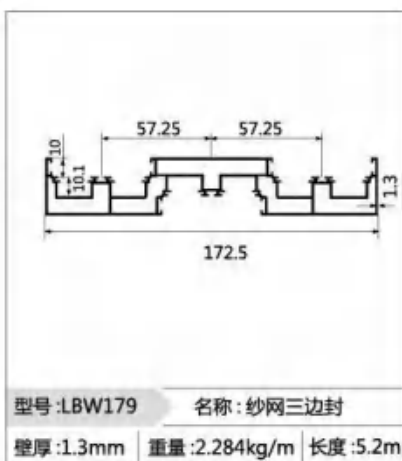
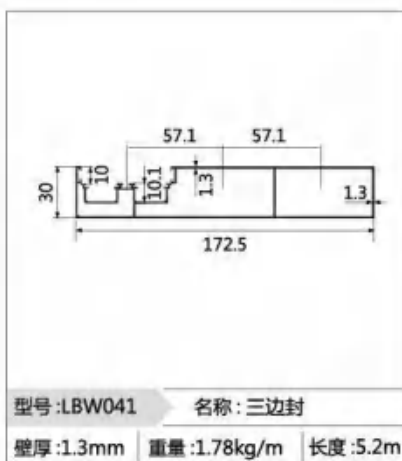
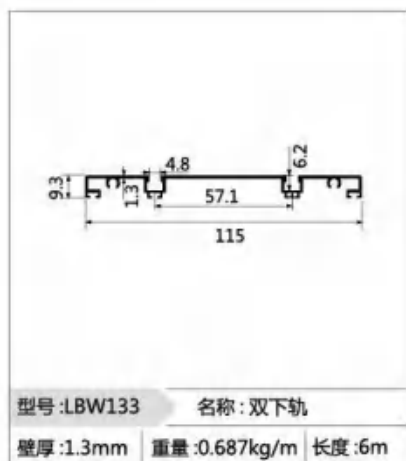
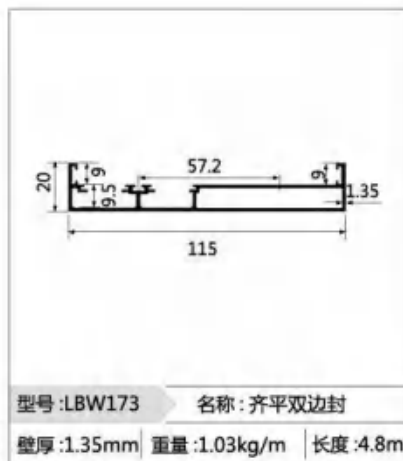
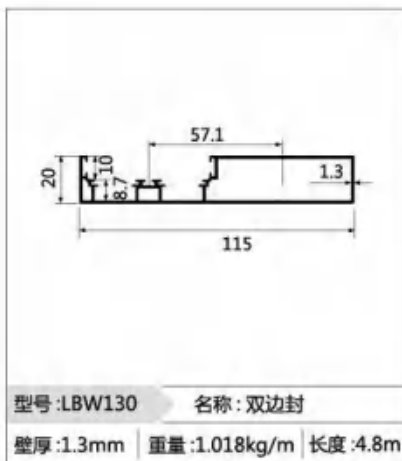
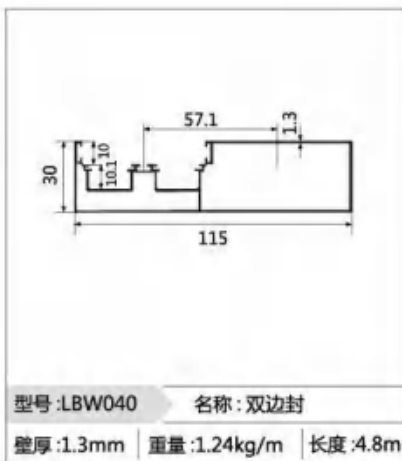
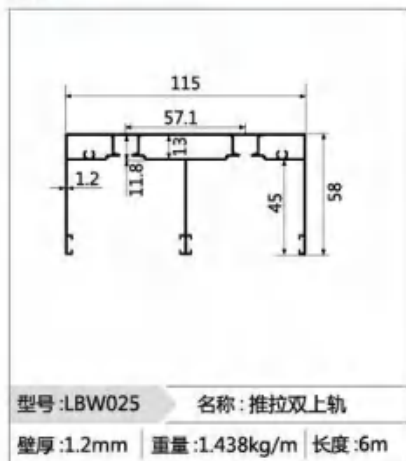

现货颜色：玳瑁黑、玳瑁白、威法金、月光灰、玉瓷灰、星空咖啡  
其他颜色可订制!



努力鸭 奋斗啊!

颜色：黑珍珠

型号:LBW027 名称:吊趟三上轨(斜轮)  
壁厚:2.5mm 重量:3.13kg/m 长度:6m

型号:LBW030 名称:三吊轨盖板  
壁厚:1.2mm 重量:0.278kg/m 长度:6m

配套  
LBW028  
LBW027

颜色：黑珍珠

型号:LBW143 名称:单吊轨(凹轮)  
壁厚:2.0mm 重量:1.202kg/m 长度:6m

配套  
LBW033  
LBW350

颜色：黑珍珠

型号:LBW142 名称:双吊轨(凹轮)  
壁厚:2.0mm 重量:2.3kg/m 长度:6m

配套  
LBW033  
LBW350

颜色：黑珍珠

型号:LBW279 名称:40/50凹轮吊轨拼条  
壁厚:1.2mm 重量:0.158kg/m 长度:6m

配套  
LBW142  
LBW143  
LBW270  
LBW259  
LBW353

型号:LBW350 名称:凹轮吊轨盖板(联动)  
壁厚:1.2mm 重量:0.281kg/m 长度:6m

配套  
LBW259  
LBW347  
LBW253  
LBW348  
LBW142  
LBW270  
LBW143

型号:LBW034 名称:推拉四联动上轨  
壁厚:1.5mm 重量:1.664kg/m 长度:6m

型号:LBW035 名称:推拉四联动上轨拼条  
壁厚:1.6mm 重量:0.135kg/m 长度:6m

配套  
LBW034

型号:LBW093 名称:两轨中柱  
壁厚:1.2mm 重量:1.115kg/m 长度:6m

型号:LBW093A 名称:两轨中柱盖板  
壁厚:1.2mm 重量:0.472kg/m 长度:6m

型号:LBW097 名称:三轨中柱  
壁厚:1.2mm 重量:1.542kg/m 长度:6m

型号:LBW097A 名称:三轨中柱盖板  
壁厚:1.2mm 重量:0.659kg/m 长度:6m

型号:LBW094A 名称:压线  
壁厚:0.8mm 重量:0.127kg/m 长度:6m

型号:LBW114 名称:包边  
壁厚:1.0mm 重量:0.416kg/m 长度:6.4m



型号:LBW044 名称:包套/前框  
壁厚:1.0mm 重量:0.54kg/m 长度:6.4m

型号:LBW045 名称:三分P槽  
壁厚:1.0mm 重量:0.170kg/m 长度:4.8m

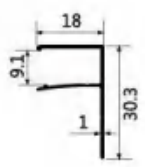
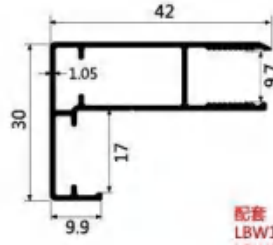
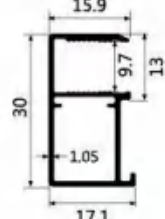
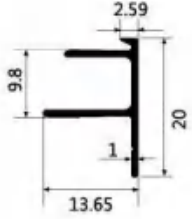
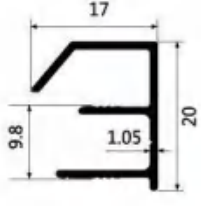
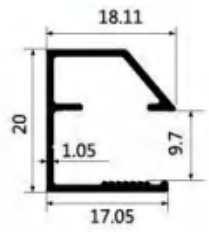
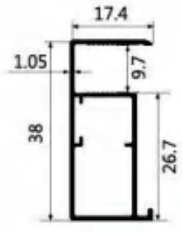
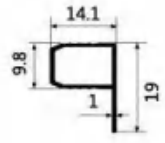
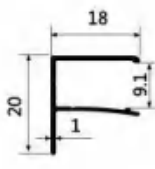
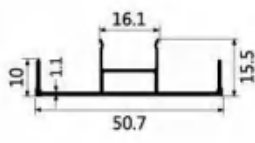
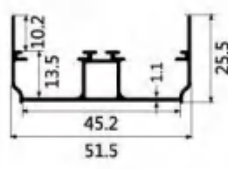
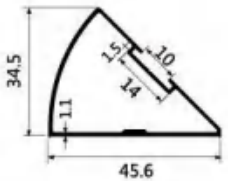
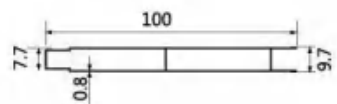
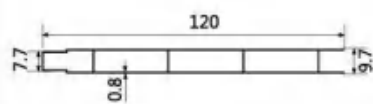
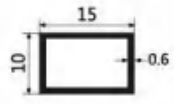

现货颜色：玳瑁黑、玳瑁白、威法金、月光灰、玉瓷灰、星空咖啡

其他颜色可订制!

	 <p>配套 LBW149 LBW155 LBW181A</p>	 <p>配套 LBW149 LBW155</p>	 <p>配套 LBW158 LBW159</p>
型号:LBW079 名称:三分F槽 壁厚:1.0mm 重量:0.165kg/m 长度:6.2m	型号:LBW157 名称:前框/包套 壁厚:1.05mm 重量:0.436kg/m 长度:6.4m	型号:LBW158 名称:包边 壁厚:1.05mm 重量:0.287kg/m 长度:6.4m	型号:LBW149 名称:2分F槽 壁厚:1.0mm 重量:0.122kg/m 长度:6.2m
 <p>配套 LBW158 LBW157</p>		 <p>配套 LBW181A</p>	
型号:LBW155 名称:底座(P槽) 壁厚:1.05mm 重量:0.175kg/m 长度:6.2m	型号:LBW156 名称:F槽 壁厚:1.05mm 重量:0.192kg/m 长度:6.2m	型号:LBW158A 名称:包边 壁厚:1.05mm 重量:0.32kg/m 长度:6.4m	型号:LBW181A 名称:2分P槽 壁厚:1.0mm 重量:0.126kg/m 长度:4.8m
			
型号:LBW137 名称:2分F槽 壁厚:1.0mm 重量:0.14kg/m 长度:6.2m	型号:LBW042 名称:边封盖板 壁厚:1.1mm 重量:0.304kg/m 长度:5.2m	型号:LBW047 名称:推拉收口 壁厚:1.1mm 重量:0.444kg/m 长度:4.8m	型号:LBW084 名称:转角 壁厚:1.1mm 重量:0.389kg/m 长度:4.8m
			
型号:LBW046A 名称:100扣板 壁厚:0.8mm 重量:0.498kg/m 长度:6.3m	型号:LBW046B 名称:120扣板 壁厚:0.8mm 重量:0.622kg/m 长度:6.3m	型号:LBW049 名称:10*15格条 壁厚:0.6mm 重量:0.078kg/m 长度:4m	



现货颜色：玳瑁黑、优雅白

其他颜色可订制!



DT-331A(方形内堵头)  
DT-331B(L形堵头)

型号:LBW331	名称:方形装饰条
壁厚:1.2mm	重量:0.2kg/m
长度:6m	



DT-332(L形堵头)

型号:LBW332	名称:装饰条
壁厚:1.2mm	重量:0.194kg/m
长度:6m	



DT-342(中柱内堵头)

型号:LBW343	名称:45方形中柱
壁厚:1.2mm	重量:0.433kg/m
长度:6m	



DT-342(内堵头)

型号:LBW342	名称:4506装饰条
壁厚:1.0mm	重量:0.167kg/m
长度:6m	

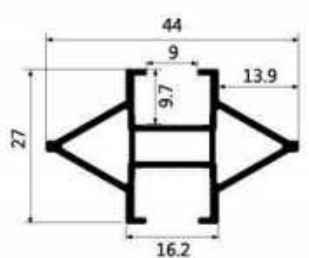

DT-344(中柱内堵头)

型号:LBW344	名称:4506老铁门中柱
壁厚:1.2mm	重量:0.503kg/m
长度:6m	



现货颜色：玳瑁黑、优雅白

其他颜色可订制!



玳瑁黑

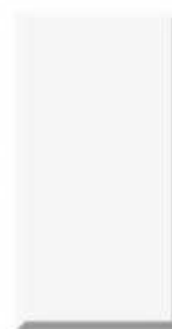

优雅白

就是这样子装的

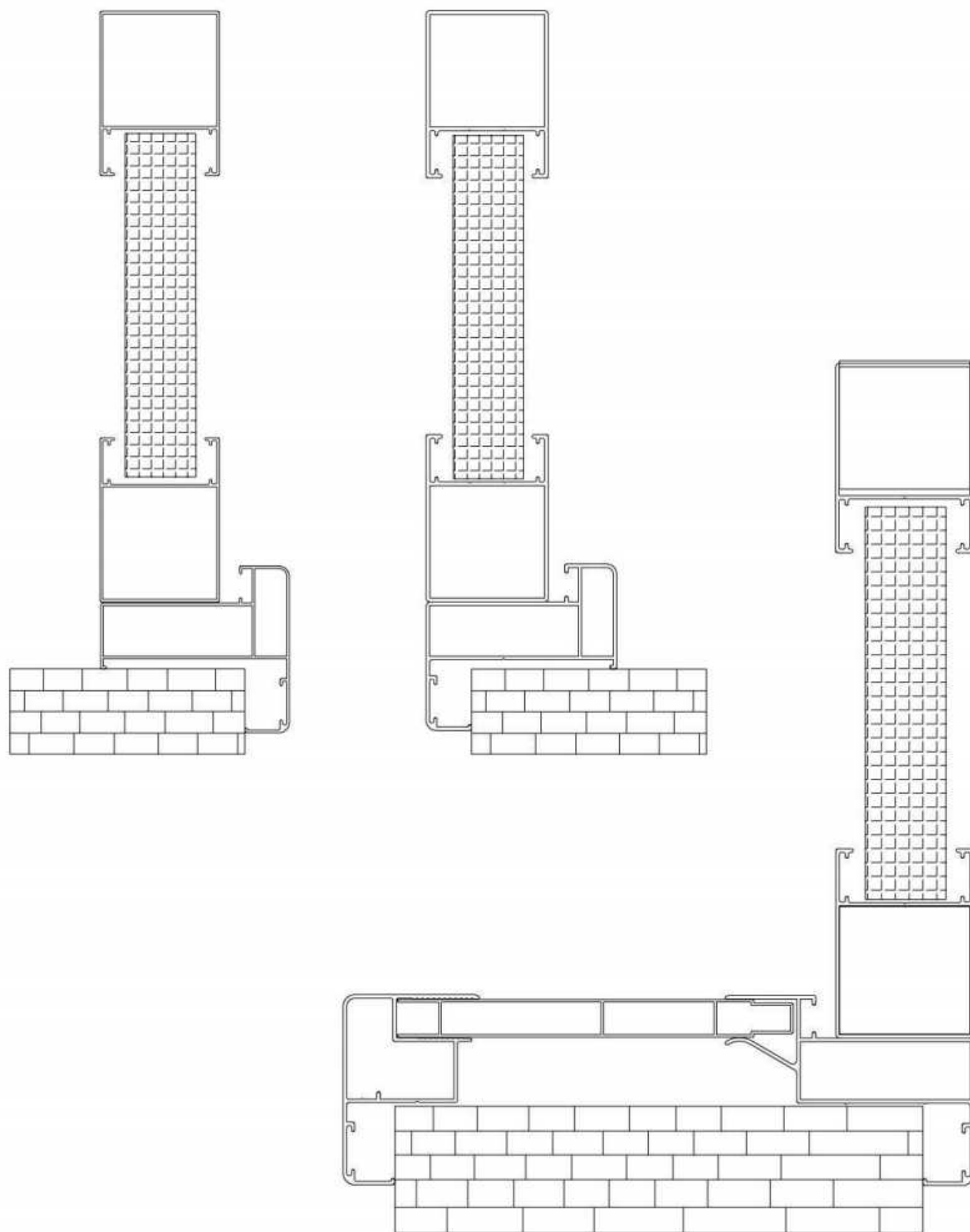

## 35 窄边 48 平开门系列 (壁厚 1.2)

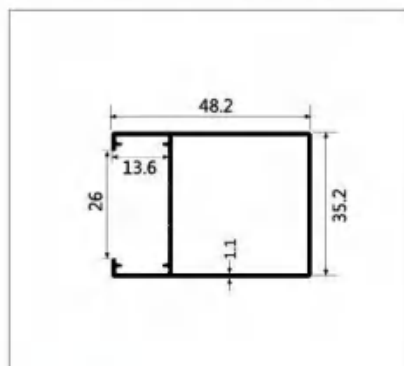

型号:LBW191 名称:1.2 平开光企  
壁厚:1.1mm 重量:0.527kg/m 长度:6.2m

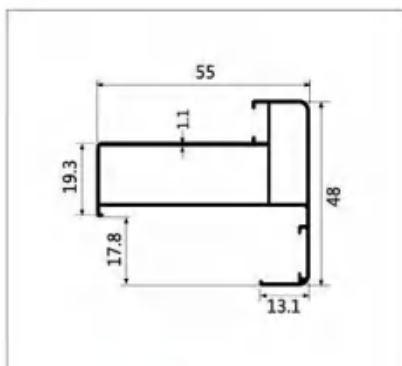

型号:LBW197 名称:1.2 外包  
壁厚:1.1mm 重量:0.61kg/m 长度:6.4m

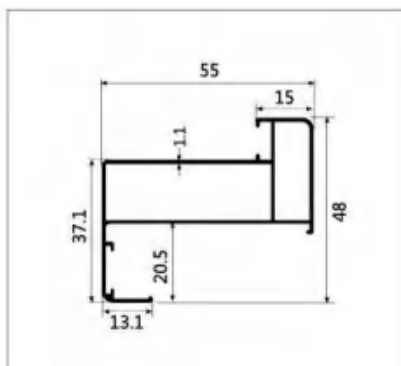

型号:LBW198 名称:1.2 内包  
壁厚:1.1mm 重量:0.61kg/m 长度:6.4m

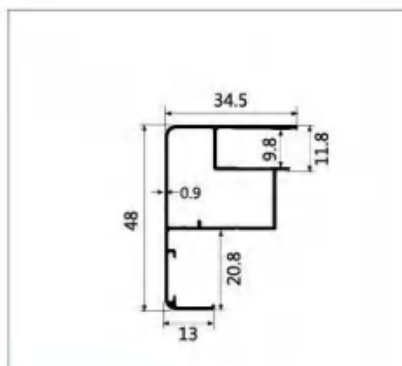

型号:LBW199 名称:前框/包边  
壁厚:0.9mm 重量:0.42kg/m 长度:6.4m

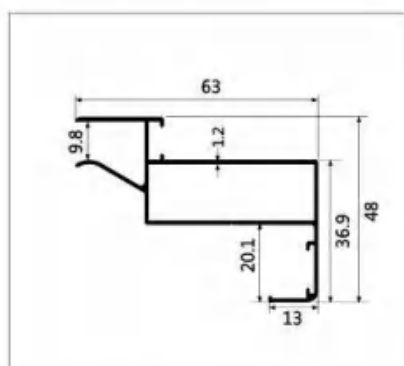

型号:LBW200 名称:1.2 双包后框  
壁厚:1.2mm 重量:0.63kg/m 长度:6.4m

### 35X48 平开门壁厚 0.8/1.0/1.2/1.4 配件通用

包套角码 :JM-114 (14*17)	角码 :JM-0635 (31.3*4.5)	微缝单玻锁 :PK-170
包套角码 (占嘴) :JM-157 (18*10.5)	角码 :JM-167	微缝双玻锁 :PK-167
包套角码 (不占嘴) :JM-158 (11.6*14)	组角片 :ZJP-304 (14.8*1.2)	天地合页 :TD-45-1A/B 左右
包边角码 :JM- (14*18)	组角片 :Z-114 (14.3*1.2)	天地合页 :TD-45-2A/B 左右
套线角码 :JM-175 (9*12)	带螺丝组角片 :Z-4450 (14.6*2)	外挂合页 :WG-45-2A/B 左右
外框角码 :JM-150-1 (49.5*10)	胶条 :JT-273275	插销 :CX-01
反包角码 :JM-51-1 (49.6*15.5)	防撞胶条 :JT-50151	隔断外框角码 :JM-110(34*4.5)
组角片 :ZJP-158A (9.2*1.0)	单玻锁 :PK-01159	隔断边封角码 :JM-113A
套线组角片 :ZJP-175 (14.8*75*2)	双玻锁 :PK-8656	隔断边封角码 :JM-113B(26.8*5.7)
单玻角码 :JM-01-1 (40.6*4.5)	斜面单玻锁 :PK-10	
双玻角码 :JM-86-1 (40.6*3.5)	斜面双玻锁 :PK-14	

你脸色红润，  
一看就是大富大贵之人！



现货颜色: 肌肤黑、优雅白、星巴咖啡、金属灰、土豪金、雪花梨木、丁香梨木、瓷美银灰、星空灰

其他颜色可订制!

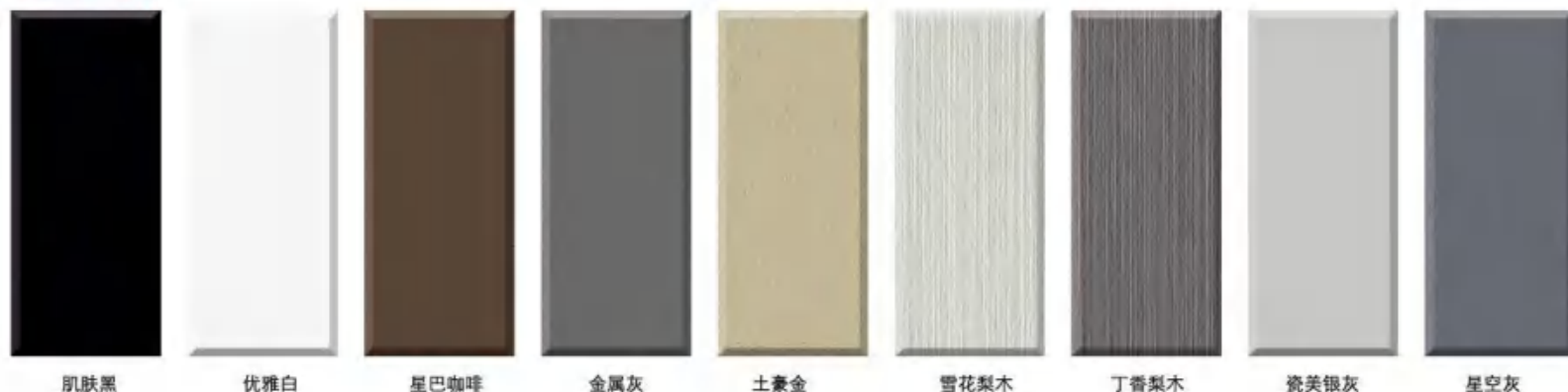

### 35x48 平开门系列 (壁厚 0.8/1.0/1.2/1.4)

#### 35 窄边 48 平开门系列 (壁厚 0.8)

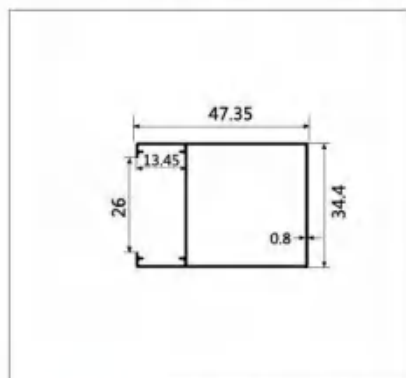

型号:LBW255 名称:0.8 平开光企  
壁厚:0.8mm 重量:0.34kg/m 长度:6.2m

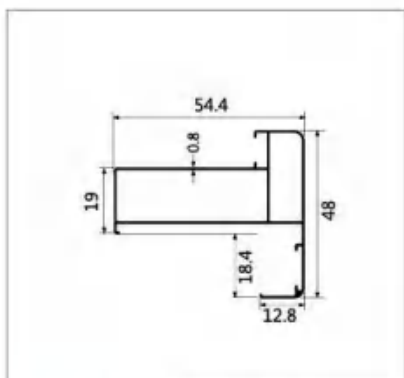

型号:LBW256 名称:0.8 外包  
壁厚:0.8mm 重量:0.44kg/m 长度:6.4m

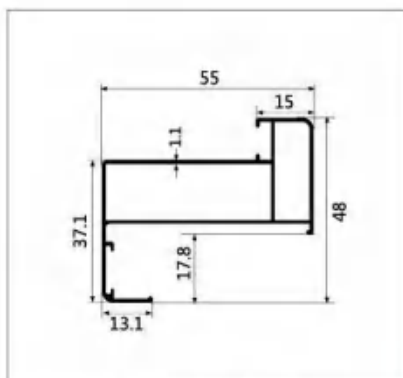

型号:LBW198 名称:1.2 内包  
壁厚:1.1mm 重量:0.61kg/m 长度:6.4m

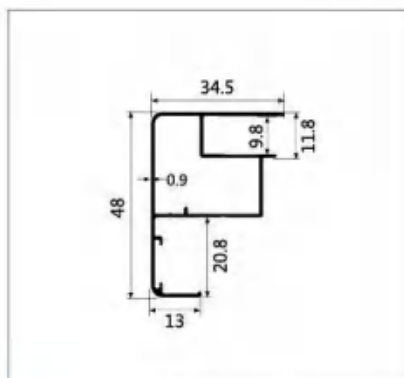

型号:LBW199 名称:前框/包边  
壁厚:0.9mm 重量:0.42kg/m 长度:6.4m

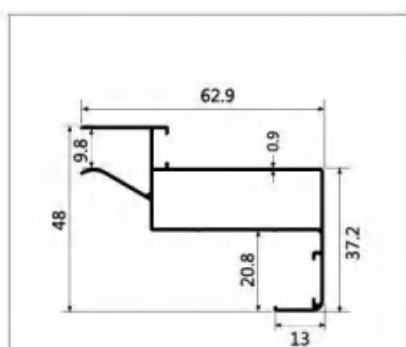

型号:LBW205 名称:1.0 双包后框  
壁厚:0.9mm 重量:0.535kg/m 长度:6.4m

吓到你了，抱歉啊  
我是成吉博蓝小旺！



肌肤黑



优雅白



星巴咖啡



金属灰



星空灰



土豪金



雪花梨木



丁香梨木



瓷美银灰

#### 35 窄边 48 平开门系列 (壁厚 1.0)

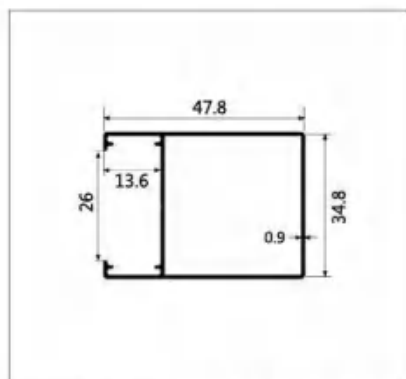

型号:LBW190 名称:1.0 平开光企  
壁厚:0.9mm 重量:0.425kg/m 长度:6.2m

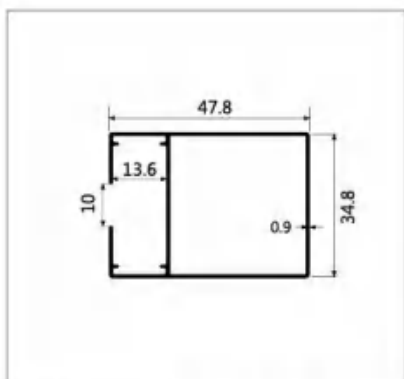

型号:LBW325 名称:1.0 平开单玻光企  
壁厚:0.9mm 重量:0.47kg/m 长度:6.2m

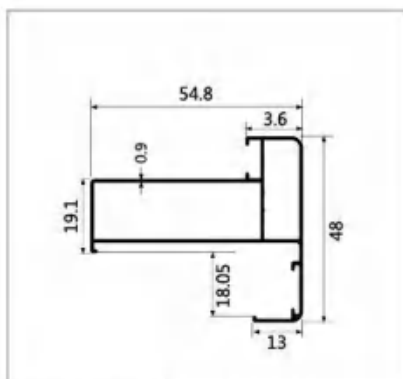

型号:LBW203 名称:1.0 外包  
壁厚:0.9mm 重量:0.555kg/m 长度:6.4m

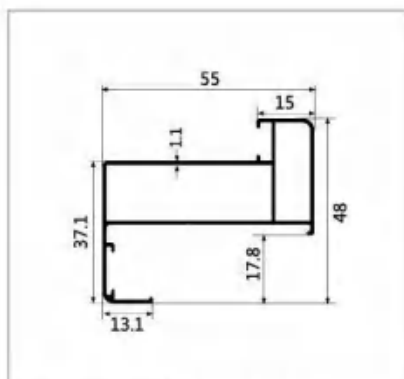

型号:LBW198 名称:1.2 内包  
壁厚:1.1mm 重量:0.61kg/m 长度:6.4m

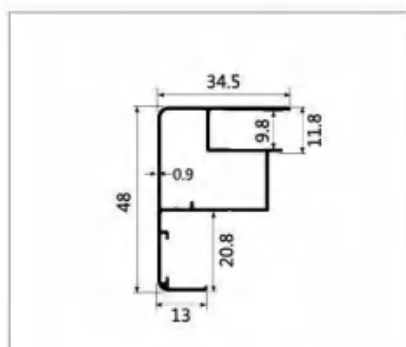

型号:LBW199 名称:前框/包边  
壁厚:0.9mm 重量:0.42kg/m 长度:6.4m

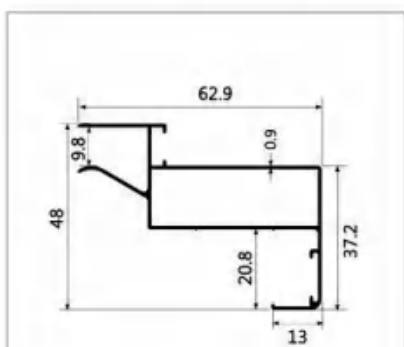

型号:LBW205 名称:1.0 双包后框  
壁厚:0.9mm 重量:0.535kg/m 长度:6.4m

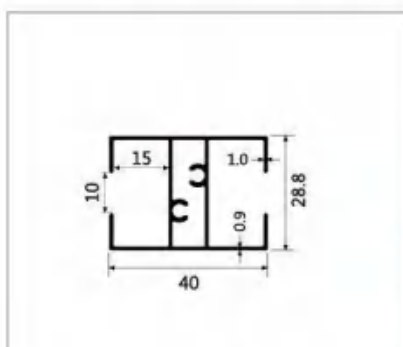

型号:LBW337 名称:单玻光企中柱  
壁厚:1.0mm 重量:0.48kg/m 长度:6m





现货颜色: 玳瑁黑、优雅白、土豪金、  
金属灰、瓷美银灰、  
星巴咖啡、雪花梨木、  
丁香梨木、星空灰

其他颜色可订制!



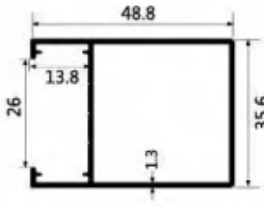
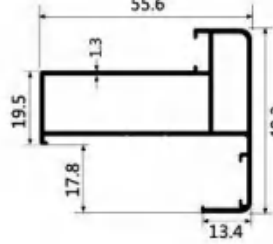
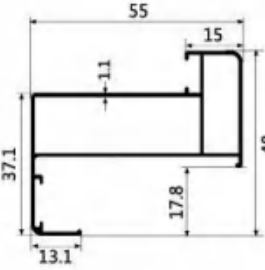

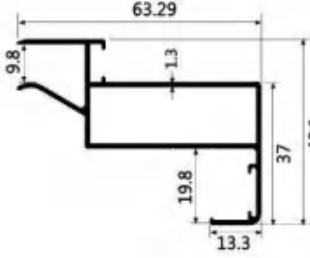
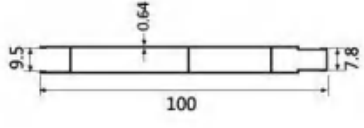
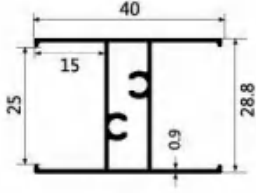
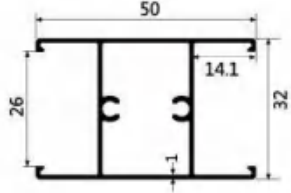
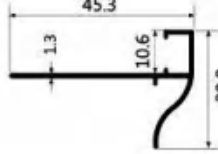
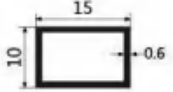
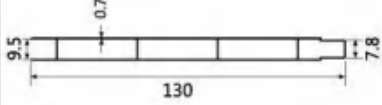
## 35 窄边 48 平开门系列 (壁厚 1.4)

 <p>型号:LBW192 名称:1.4 平开光企 壁厚:1.3mm 重量:0.613kg/m 长度:6.2m</p>	 <p>型号:LBW207 名称:1.4 外包 壁厚:1.3mm 重量:0.766kg/m 长度:6.4m</p>	 <p>型号:LBW198 名称:内包 壁厚:1.1mm 重量:0.61kg/m 长度:6.4m</p>	 <p>型号:LBW199 名称:前框/包边 壁厚:0.9mm 重量:0.42kg/m 长度:6.4m</p>
 <p>型号:LBW208 名称:1.4 双包后框 壁厚:1.3mm 重量:0.752kg/m 长度:6.4m</p>	 <p>型号:LBW201 名称:100 扣板 壁厚:0.64mm 重量:0.41kg/m 长度:6.3m</p>	 <p>型号:LBW204 名称:双玻光企中柱 壁厚:0.9mm 重量:0.392 kg/m 长度:6m</p> <p style="color: red;">用完换 LBW374</p>	 <p>型号:LBW374 名称:35 光企中柱 壁厚:1.0mm 重量:0.521kg/m 长度:6m</p>
 <p>型号:LBW206 名称:平开收口 壁厚:1.3mm 重量:0.285kg/m 长度:4.8m</p>	 <p>型号:LBW049 名称:10*15 格条 壁厚:0.6mm 重量:0.078kg/m 长度:4m</p>	 <p>型号:LBW202 名称:130 扣板 壁厚:0.7mm 重量:0.568kg/m 长度:6.3m</p>	

现货颜色: 肌肤黑、优雅白、星巴咖啡、金属灰、土豪金、雪花梨木、丁香梨木、瓷美银灰、星空灰

其他颜色可订制!

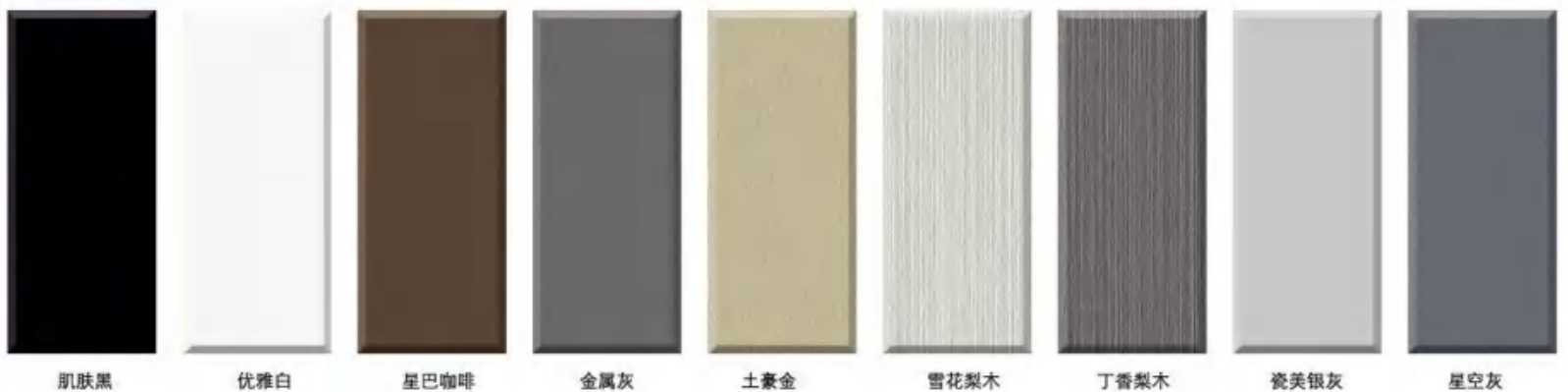

## 35x48 推拉 / 吊趟门系列 (壁厚 1.0/1.2/1.4/2.0)

### 35 窄边 48 推拉门系列 (壁厚 1.0)

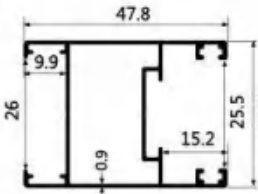
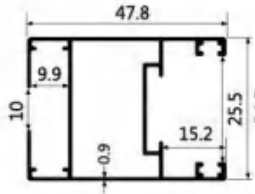
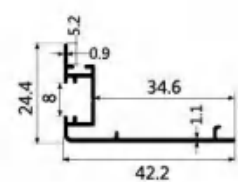
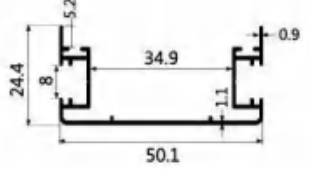
			
型号:LBW193 名称:1.0 推拉光企 壁厚:0.9mm 重量:0.519kg/m 长度:6.3m	型号:LBW326 名称:1.0 单玻推拉光企 壁厚:0.9mm 重量:0.56kg/m 长度:6.3m	型号:LBW209 名称:单勾企 壁厚:0.9mm 重量:0.265kg/m 长度:4.8m	型号:LBW210 名称:双勾企 壁厚:0.9mm 重量:0.39kg/m 长度:4.8m

### 35 窄边 48 推拉门系列 (壁厚 1.2)

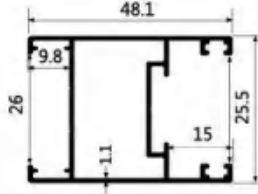
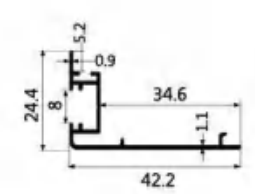
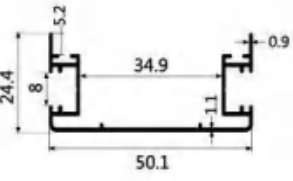
		
型号:LBW194 名称:1.2 推拉光企 壁厚:1.1mm 重量:0.613kg/m 长度:6.3m	型号:LBW209 名称:单勾企 壁厚:0.9mm 重量:0.265kg/m 长度:4.8m	型号:LBW210 名称:双勾企 壁厚:0.9mm 重量:0.39kg/m 长度:4.8m

我给你讲个笑话

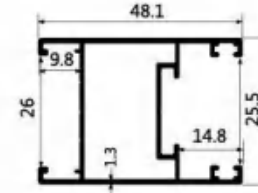
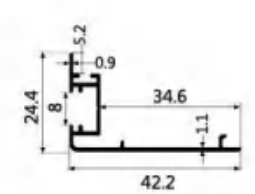
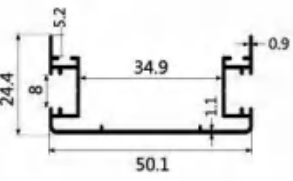

### 35 窄边 48 推拉门系列 (壁厚 1.4)

		
型号:LBW195 名称:1.4 推拉光企 壁厚:1.3mm 重量:0.663kg/m 长度:6.3m	型号:LBW209 名称:单勾企 壁厚:0.9mm 重量:0.265kg/m 长度:4.8m	型号:LBW210 名称:双勾企 壁厚:0.9mm 重量:0.39kg/m 长度:4.8m



现货颜色: 肌肤黑、优雅白、星巴咖啡、金属灰、土豪金、雪花梨木、丁香梨木、瓷美银灰、星空灰

其他颜色可订制!

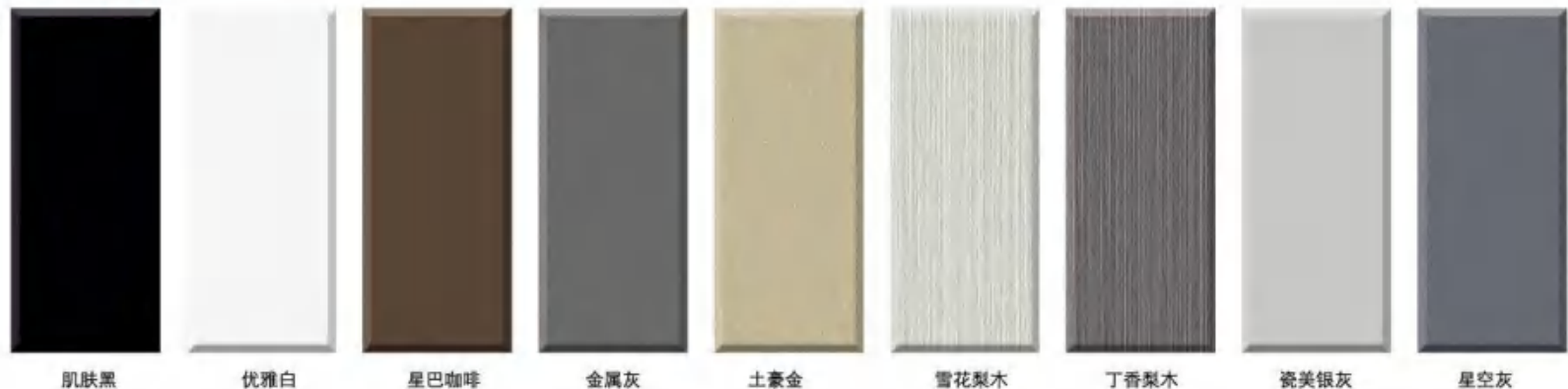

肌肤黑

优雅白

星巴咖啡

金属灰

土豪金

雪花梨木

丁香梨木

瓷美银灰

星空灰

## 35 窄边 48 推拉门系列 (壁厚 2.0)

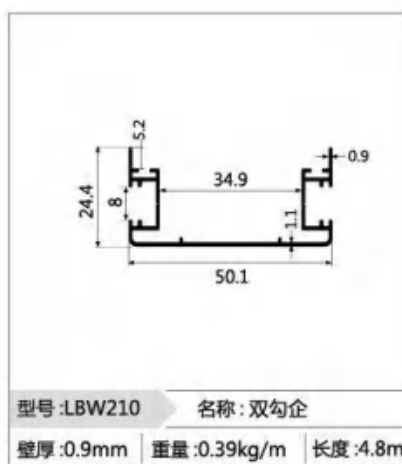
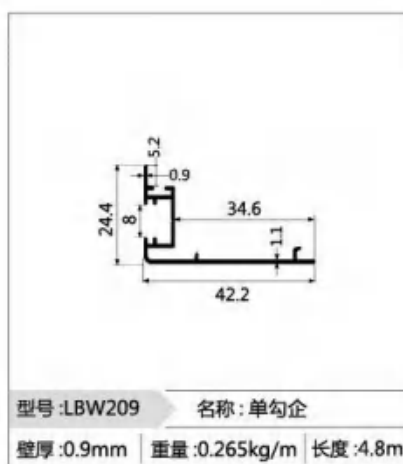

35X48 推拉门配件		
包套角码 :JM-114 (14*17)	光企角码 :JMS-3548-TL (16*30.8)	边封堵头 :DT-35483565
包套角码 (占槽) :JM-157 (18*10.5)	光企组角片 :ZJP-3548-TLA (5*1.2) 小	不带缓冲吊轮 (平轮) :DT-3548.3565
包套角码 (不占槽) :JM-158 (11.6*14)	光企组角片 :ZJP-3548-TLB (8.3*1.2) 大	不带缓冲吊轮 (凹轮) :DT-3548.3565A
套线组角片 :ZJP-175 (14.8*75*2)	勾企胶条 :JT-209210235238(3.8)	单缓冲吊轮 (凹轮) :DT-3548.3565B
组角片 :ZJP-158A (9.2*1.0)	边封胶条 :JT-211.216231236(4.5 偏)	双缓冲吊轮 (凹轮) :DT-3548.3565C
组角片 :ZJP-304 (14.8*1.2)	边封卡条 :KT-002(048)	单缓冲器 :TLHC-DX (单轨不可用)
组角片 :Z-114 (14.3*1.2)	边封毛条 :MT-02(5*6)	单缓冲器 :TLHC-DX-1
带螺丝组角片 :Z-4450 (14.6*2)	勾企毛条 :MT-03(10*5)	双缓冲器 :TLHC-SX (单轨不可用)
上轮 :SL-3548 (9.5*15)	不锈钢导轨 :XG-01	
下轮 :XL-3548-2 (15*17)	自粘不锈钢导轨 :XG-01-1	

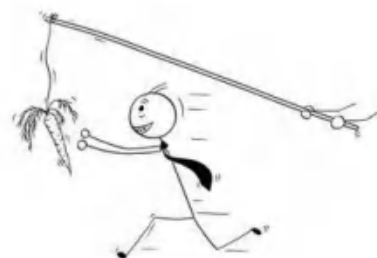

跟男朋友分手了，他气的夺门而出，

我追了他八条街，才把门抢了回来

现货颜色：肌肤黑、优雅白、星巴咖啡、金属灰、土豪金、雪花梨木、丁香梨木、瓷美银灰、星空灰

其他颜色可订制!

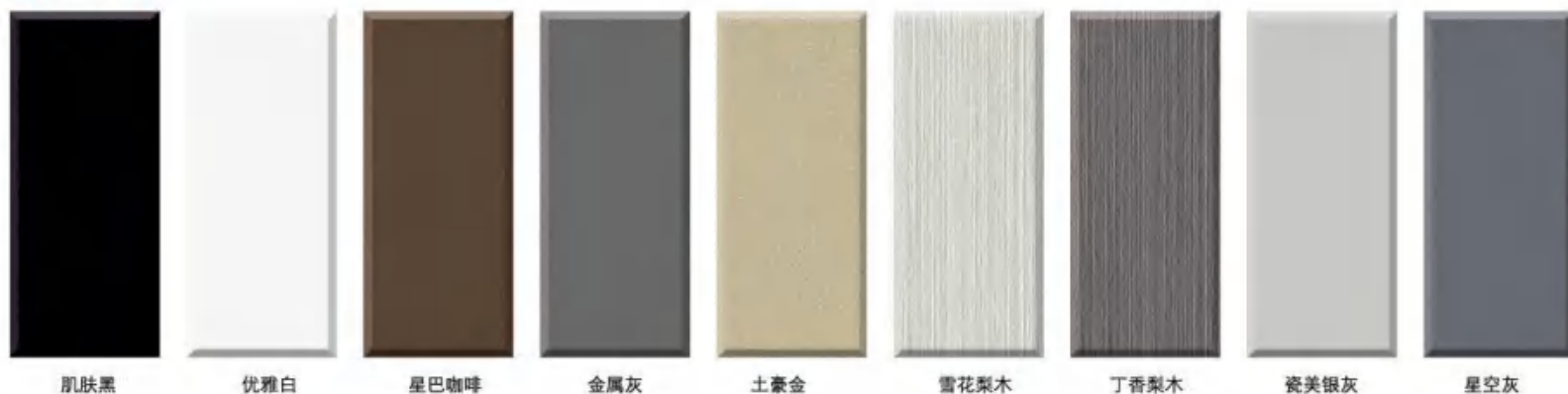



现货颜色: 肌肤黑、优雅白、星巴咖啡、金属灰、土豪金、雪花梨木、丁香梨木、瓷美银灰、星空灰  
其他颜色可订制!

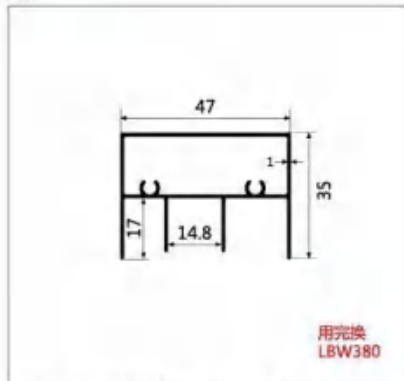

用完换  
LBW380

型号:LBW217 名称:单上轨  
壁厚:1.0mm 重量:0.57kg/m 长度:6m

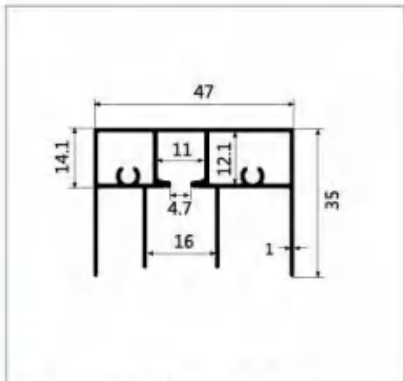

型号:LBW380 名称:单上轨  
壁厚:1.0mm 重量:0.66kg/m 长度:5.8m

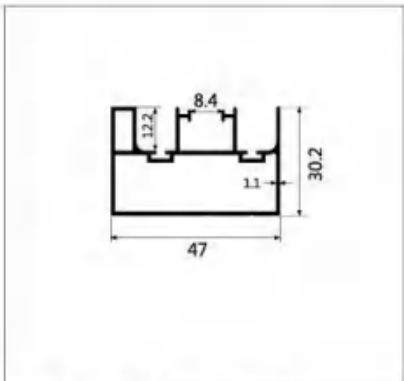

型号:LBW214 名称:单边封  
壁厚:1.1mm 重量:0.65kg/m 长度:4.8m

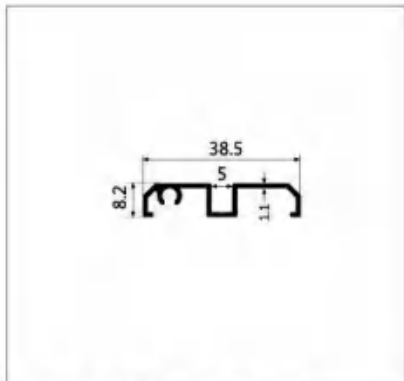

型号:LBW220 名称:单下轨  
壁厚:1.2mm 重量:0.244kg/m 长度:6m

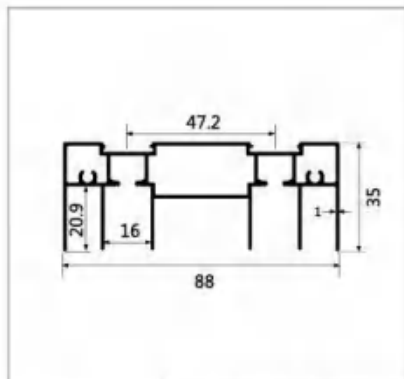

型号:LBW218 名称:双上轨  
壁厚:1.1mm 重量:1.2kg/m 长度:6m

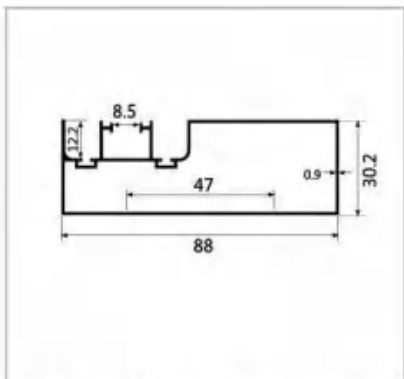

型号:LBW211 名称:1.0 双边封  
壁厚:0.9mm 重量:0.74kg/m 长度:4.8m

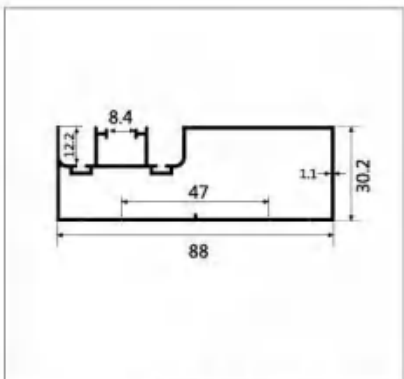

型号:LBW212 名称:1.2 双边封  
壁厚:1.1mm 重量:0.87kg/m 长度:4.8m

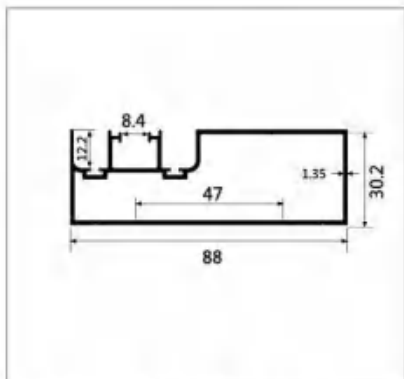

型号:LBW213 名称:1.4 双边封  
壁厚:1.35mm 重量:1.031kg/m 长度:4.8m

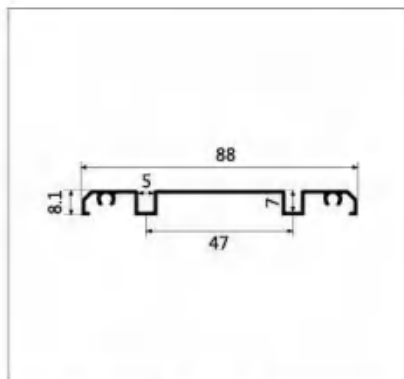

型号:LBW221 名称:双下轨  
壁厚:1.1mm 重量:0.45kg/m 长度:6m

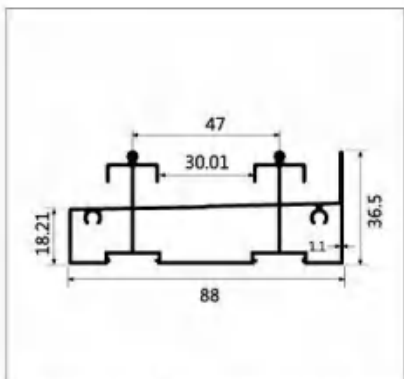

型号:LBW223 名称:两轨高地轨  
壁厚:1.1mm 重量:1.223kg/m 长度:6m

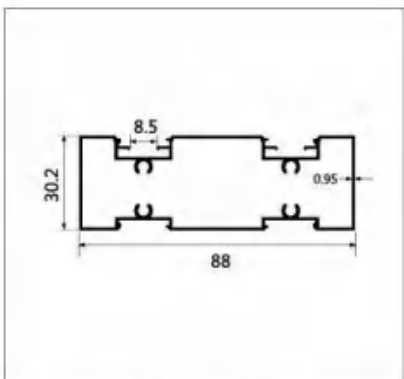

型号:LBW226 名称:两轨中柱  
壁厚:0.95mm 重量:0.91kg/m 长度:6m

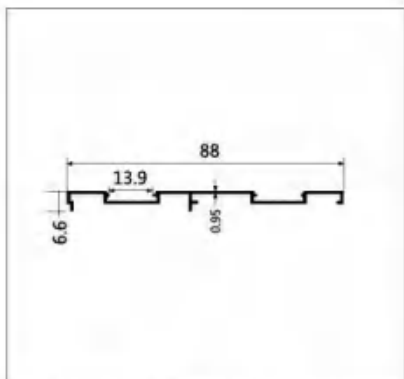

型号:LBW228 名称:两轨中柱盖板  
壁厚:0.95mm 重量:0.33kg/m 长度:6m

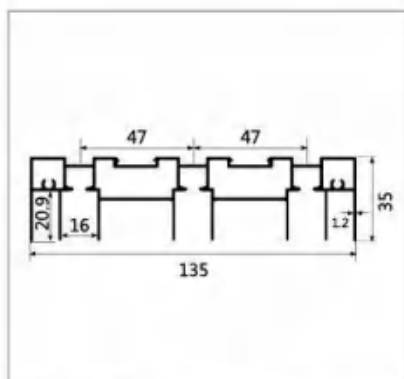

型号:LBW219 名称:三上轨  
壁厚:1.2mm 重量:1.8kg/m 长度:6m

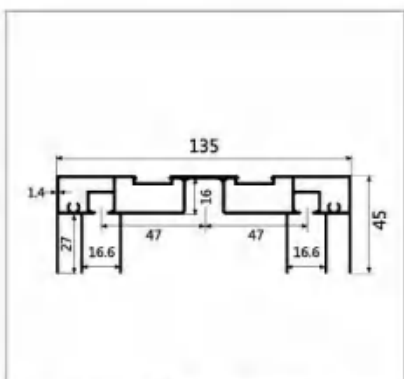

型号:LBW233 名称:三联动上轨  
壁厚:1.4 重量:2.11kg/m 长度:6m

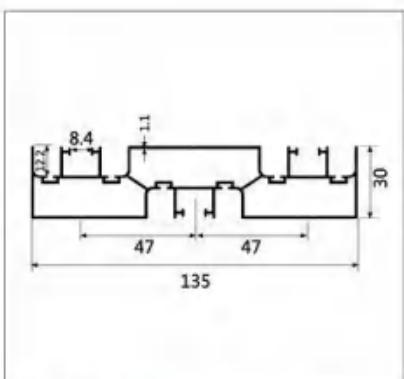

型号:LBW216 名称:1.2 三边封  
壁厚:1.1mm 重量:1.56kg/m 长度:5.1m

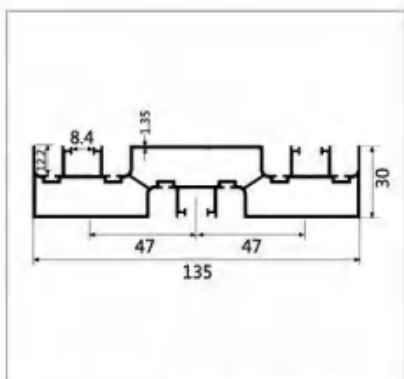

型号:LBW215 名称:1.4 三边封  
壁厚:1.35mm 重量:1.855kg/m 长度:5.1m



# 35x48 推拉 / 吊趟门系列 (壁厚 1.0/1.2/1.4/2.0)

高端系统门窗 - 定制极窄铝型材  
High-end system doors and windows - custom ultra-thin aluminum profiles

现货颜色: 肌肤黑、优雅白、星巴咖啡、金属灰、土豪金、雪花梨木、丁香梨木、瓷美银灰、星空灰  
其他颜色可订制!

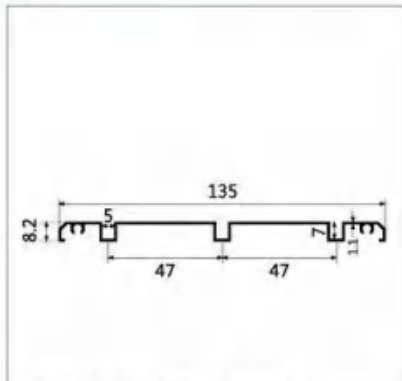

型号:LBW222 名称:三下轨  
壁厚:1.1mm 重量:0.64kg/m 长度:6m

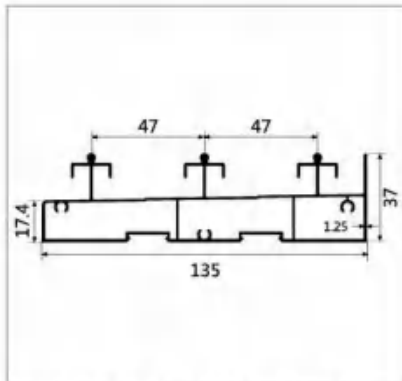

型号:LBW230 名称:三轨高地轨  
壁厚:1.25mm 重量:1.74kg/m 长度:6m

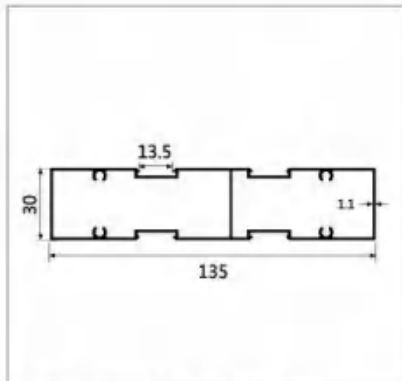

型号:LBW227 名称:三轨中柱  
壁厚:1.1mm 重量:1.313kg/m 长度:6m

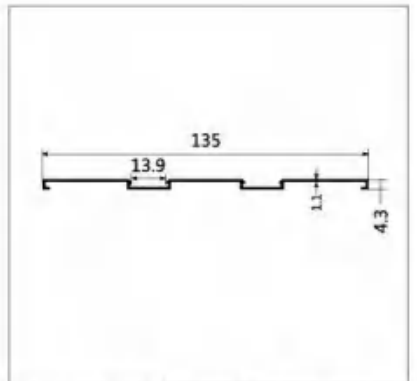

型号:LBW229 名称:三轨中柱盖板  
壁厚:1.1mm 重量:0.49kg/m 长度:6m

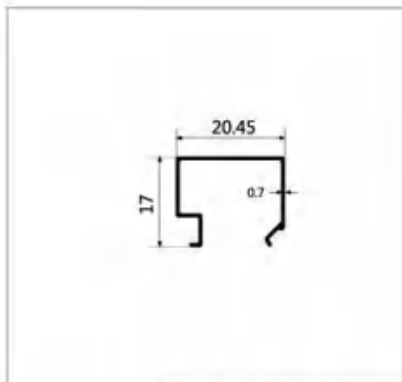

型号:LBW232 名称:方形压线  
壁厚:0.7mm 重量:0.12kg/m 长度:6m



型号:LBW231 名称:推拉收口  
壁厚:1.0mm 重量:0.25kg/m 长度:4.8m

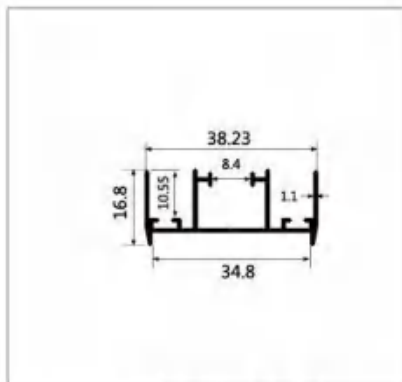

型号:LBW236 名称:推拉收口  
壁厚:1.0mm 重量:0.335kg/m 长度:4.8m

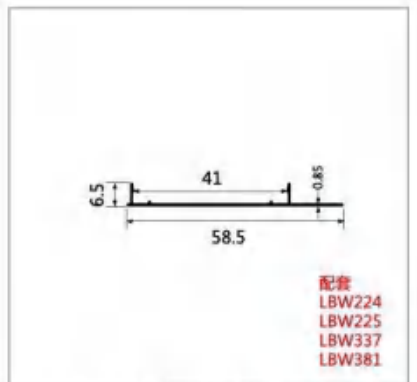

型号:LBW234 名称:吊轨盖板  
壁厚:0.85mm 重量:0.164kg/m 长度:6.2m

配套  
LBW224  
LBW225  
LBW337  
LBW381

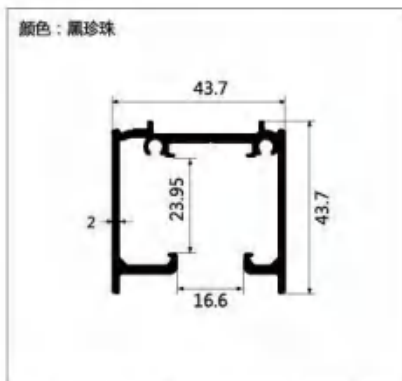

型号:LBW381 名称:单轨吊轨(凹轮)  
壁厚:2.0mm 重量:1.006kg/m 长度:5.8m



型号:LBW224 名称:单吊轨(平轮)  
壁厚:2.0mm 重量:1.01kg/m 长度:6m



型号:LBW237 名称:双吊轨(凹轮)  
壁厚:2.2mm 重量:1.97kg/m 长度:6m

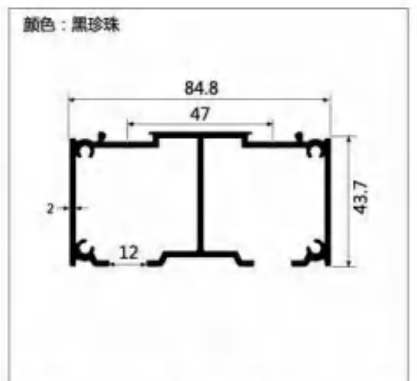

型号:LBW225 名称:双吊轨(平轮)  
壁厚:2.0mm 重量:1.65kg/m 长度:6m

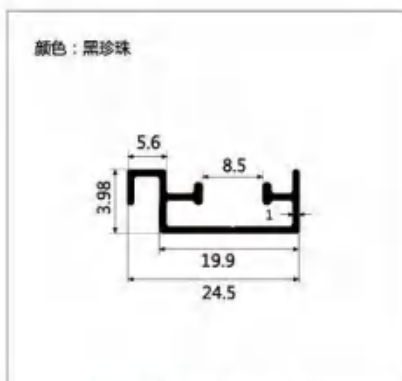

型号:LBW335 名称:纱网料  
壁厚:1.0mm 重量:0.165kg/m 长度:6m

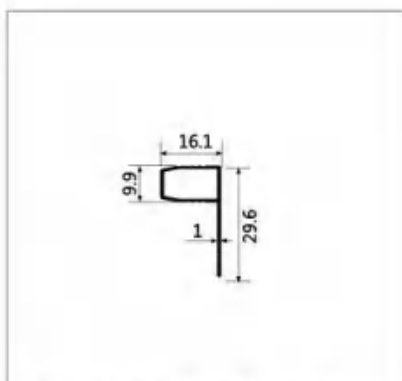

型号:LBW045 名称:三分P槽  
壁厚:1.0mm 重量:0.170kg/m 长度:4.8m

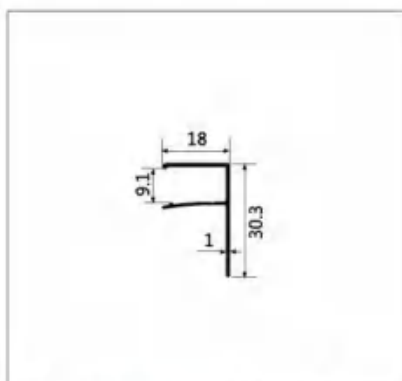

型号:LBW079 名称:三分F槽  
壁厚:1.0mm 重量:0.165kg/m 长度:6.2m

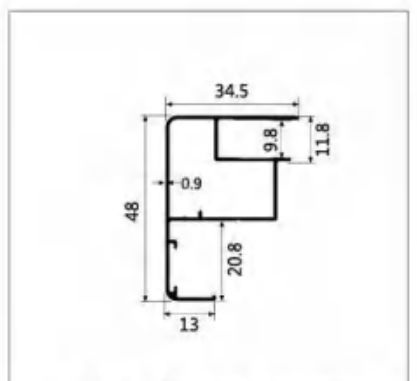

型号:LBW199 名称:前框/包边  
壁厚:0.9mm 重量:0.42kg/m 长度:6.4m

就是这样子装的

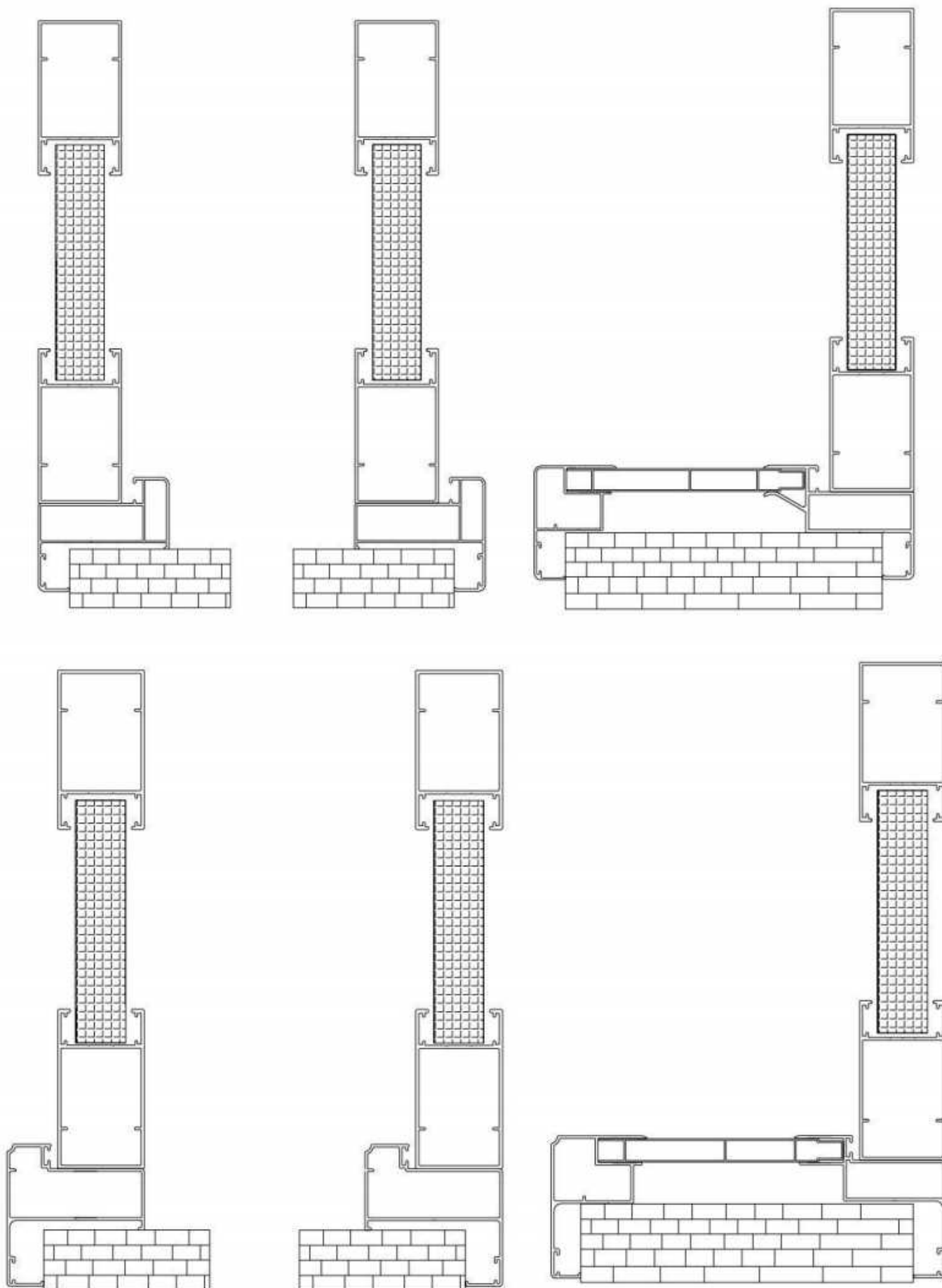

## 35X65 平开门系列 (壁厚 1.2)

<p>型号:LBW239 名称:1.2 平开光企 壁厚:1.1mm 重量:0.66kg/m 长度:6.2m</p>	<p>型号:LBW200 名称:1.2 双包后框 壁厚:1.0mm 重量:0.63kg/m 长度:6.4m</p>	<p>型号:LBW197 名称:1.2 外包 壁厚:1.0mm 重量:0.61kg/m 长度:6.4m</p>	<p>型号:LBW198 名称:内包 壁厚:1.1mm 重量:0.61kg/m 长度:6.4m</p>
<p>型号:LBW199 名称:前框/包边 壁厚:0.9mm 重量:0.42kg/m 长度:6.4m</p>	<p>型号:LBW377 名称:1.2 外包 壁厚:1.1mm 重量:0.671kg/m 长度:6.4m</p>	<p>型号:LBW378 名称:1.2 双包前框 壁厚:1.1mm 重量:0.55kg/m 长度:6.4m</p>	<p>型号:LBW379 名称:1.2 双包后框 壁厚:1.1mm 重量:0.63kg/m 长度:6.4m</p>
	<p>我很伤心 早知道他不是东西，就是忘了说了！</p>		
<p>型号:LBW382 名称:1.2 内包 壁厚:1.1mm 重量:0.692kg/m 长度:6.4m</p>			

现货颜色: 肌肤黑、优雅白、星巴咖啡、金属灰、土豪金、雪花梨木、丁香梨木、瓷美银灰、星空灰

其他颜色可订制!

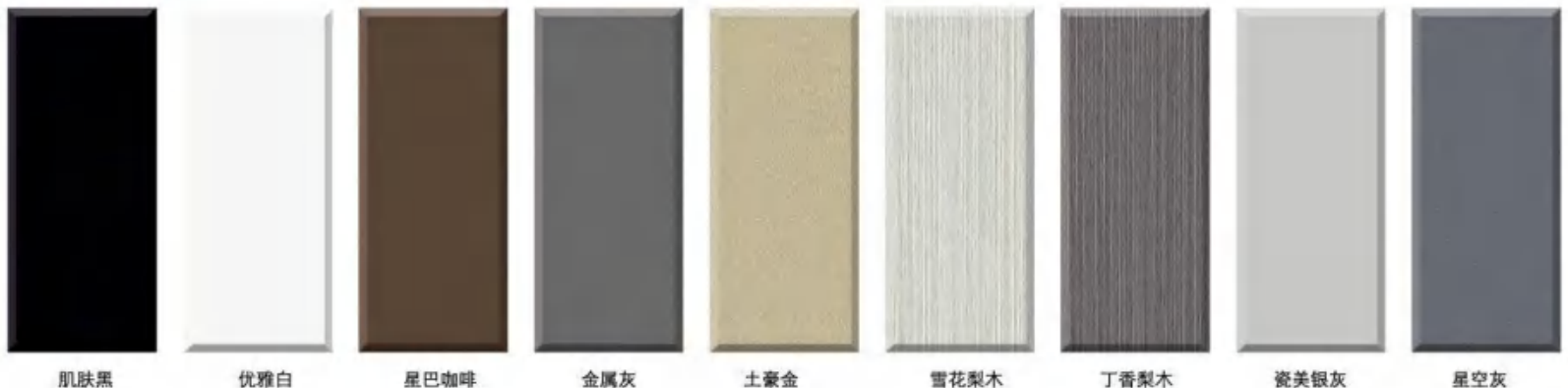

肌肤黑

优雅白

星巴咖啡

金属灰

土豪金

雪花梨木

丁香梨木

瓷美银灰

星空灰

## 35x65 平开门系列 (壁厚 1.2/1.4)

现货颜色: 肌肤黑、优雅白、星巴咖啡、金属灰、土豪金、雪花梨木、丁香梨木、瓷美银灰、星空灰

其他颜色可订制!

35X65 平开门系列 (壁厚 1.4)

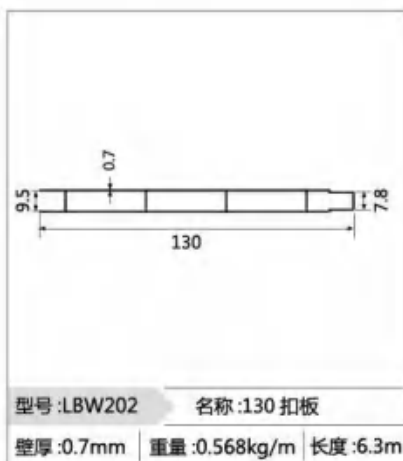
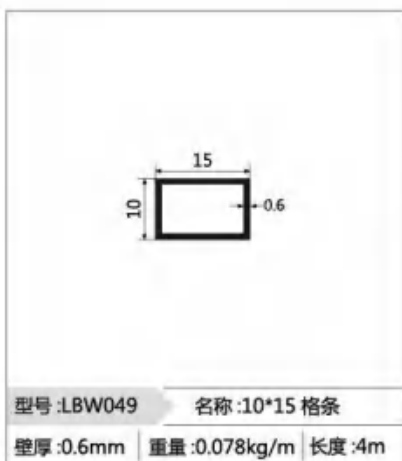
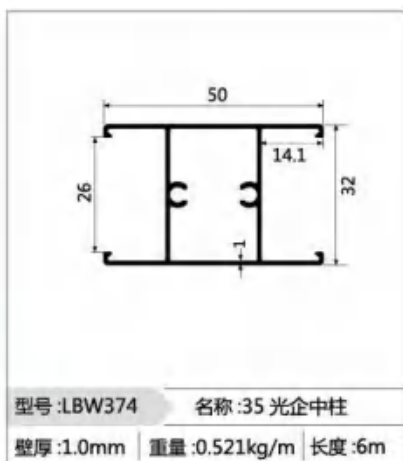
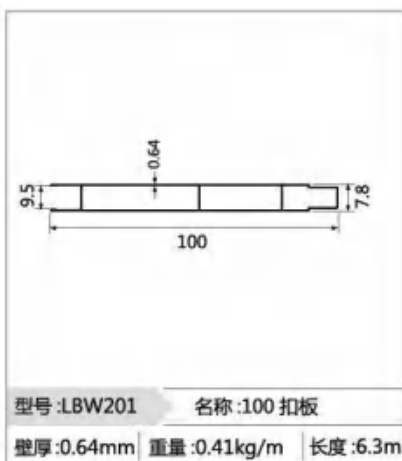
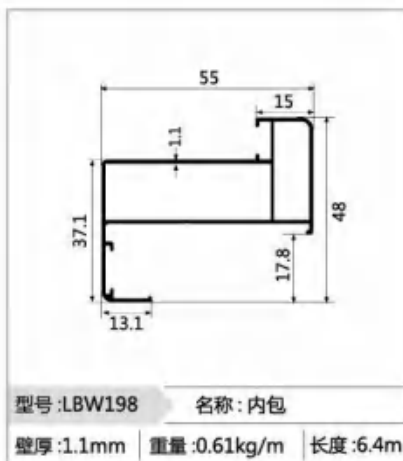

现货颜色: 肌肤黑、优雅白、星巴咖啡、金属灰、土豪金、雪花梨木、丁香梨木、瓷美银灰、星空灰

其他颜色可订制!

35x65 中窄平开门配件	
平开锁整套:	3565/4265 平开锁 (裸锁) 28 面
	35 可调锁盒
	3565 锁芯胶 33*14.5
	30 锁芯胶 3565/4265
后框角码: (14*42)	外挂合页: 左右 (14*18)
包边角码: (14*18)	天地合页: 左右 (14*18)
胶条: (14*18)	外框组角片: (12.3*1.2)

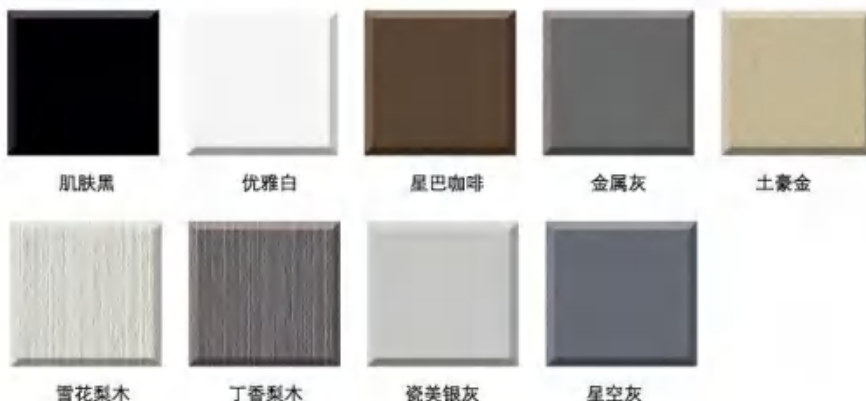



就是这样子装的

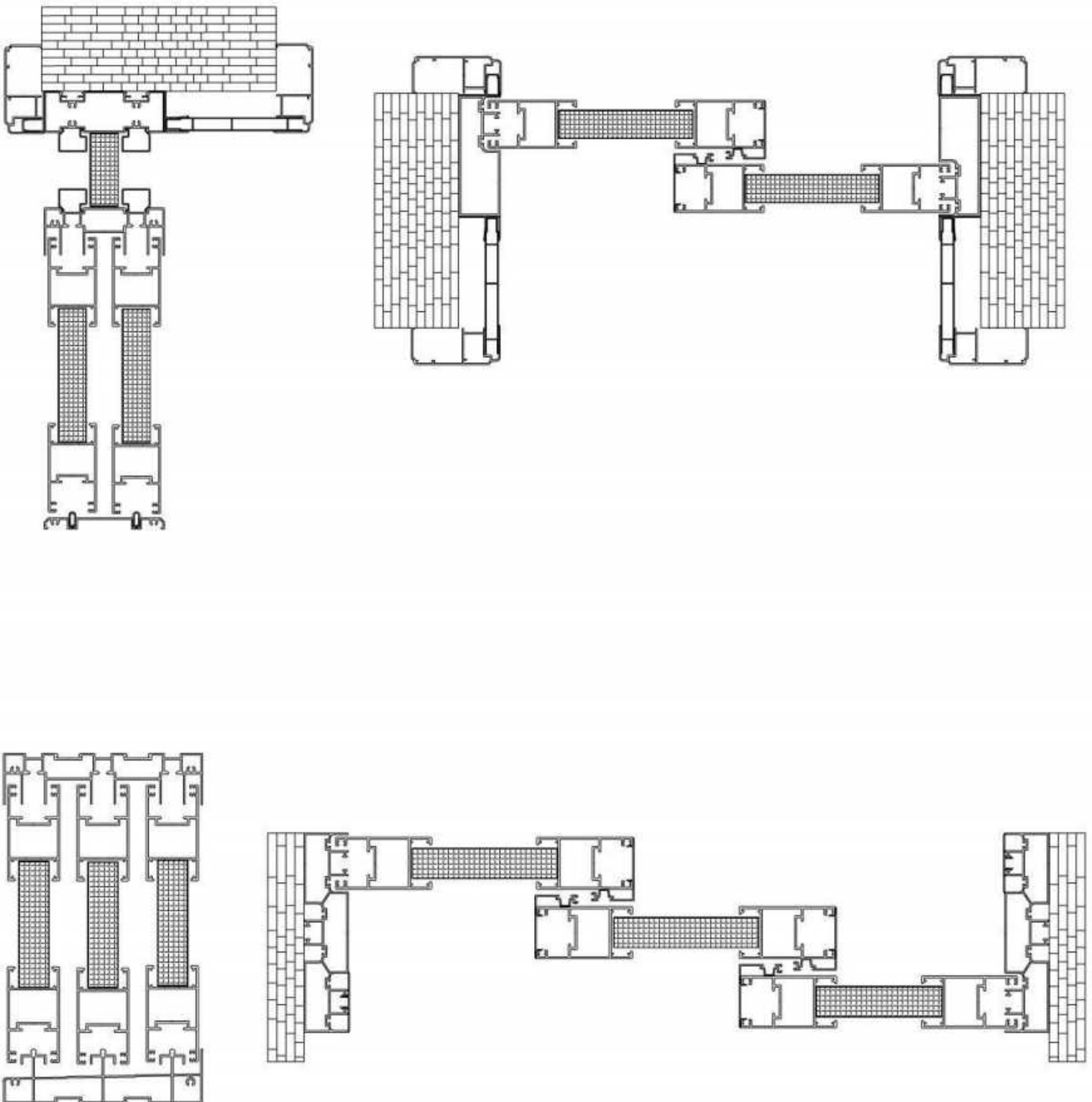

#### 35X65 推拉门系列 (壁厚 1.2)

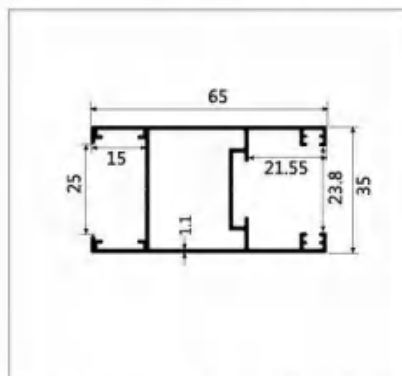

型号:LBW248 名称:1.2 推拉光企  
壁厚:1.1mm 重量:0.754kg/m 长度:6.3m

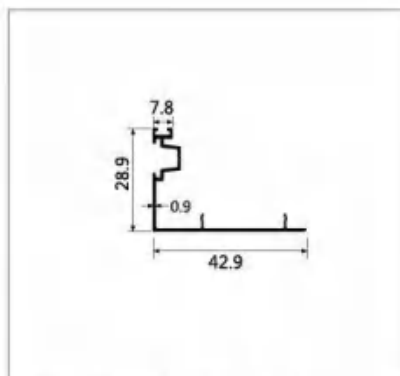

型号:LBW238 名称:单勾企  
壁厚:0.9mm 重量:0.237kg/m 长度:4.8m

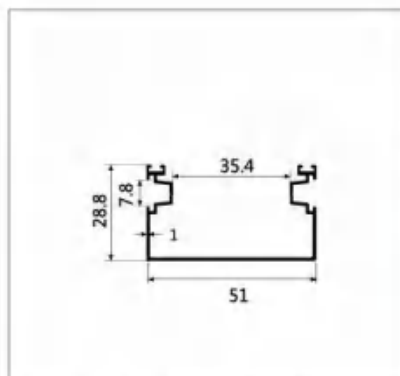

型号:LBW235 名称:双勾企  
壁厚:1.0mm 重量:0.38kg/m 长度:4.8m



现货颜色: 肌肤黑、优雅白、  
星巴咖啡、金属灰、土豪金、  
雪花梨木、丁香梨木、瓷美银灰、  
星空灰  
其他颜色可订制!

#### 35X65 推拉门系列 (壁厚 1.4)

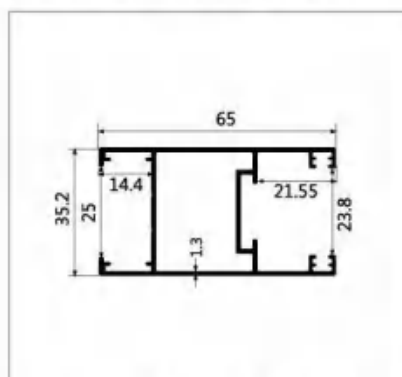

型号:LBW249 名称:1.4 推拉光企  
壁厚:1.3mm 重量:0.86kg/m 长度:6.3m

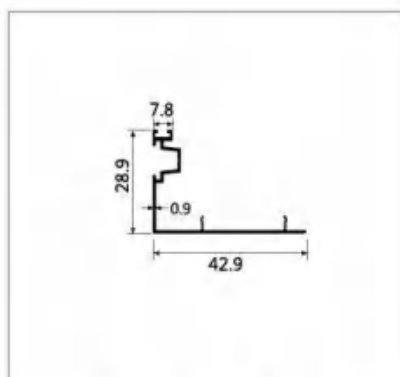

型号:LBW238 名称:单勾企  
壁厚:0.9mm 重量:0.237kg/m 长度:4.8m

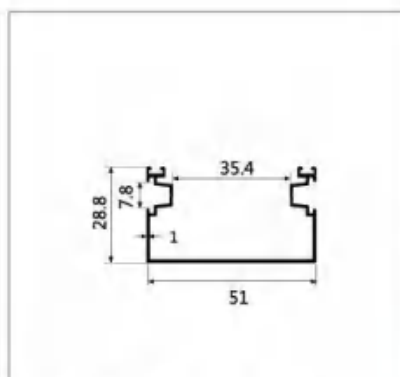

型号:LBW235 名称:双勾企  
壁厚:1.0mm 重量:0.38kg/m 长度:4.8m



现货颜色: 肌肤黑、优雅白、  
星巴咖啡、金属灰、土豪金、  
雪花梨木、丁香梨木、瓷美银灰、  
星空灰  
其他颜色可订制!

#### 35X65 推拉门系列 (壁厚 2.0)

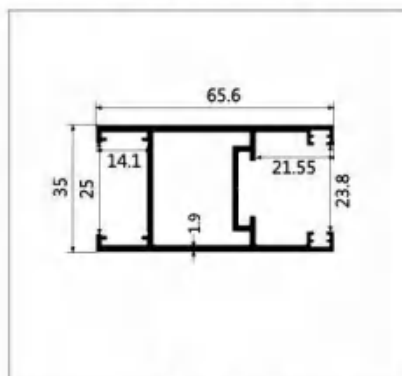

型号:LBW250 名称:2.0 推拉光企  
壁厚:1.9mm 重量:1.1kg/m 长度:6.3m

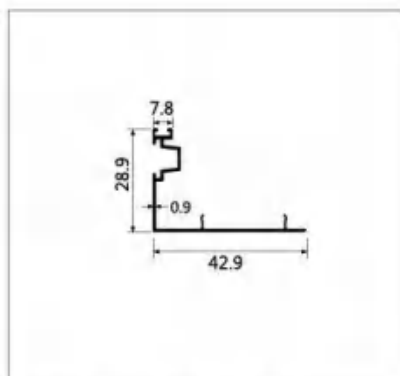

型号:LBW238 名称:单勾企  
壁厚:0.9mm 重量:0.237kg/m 长度:4.8m

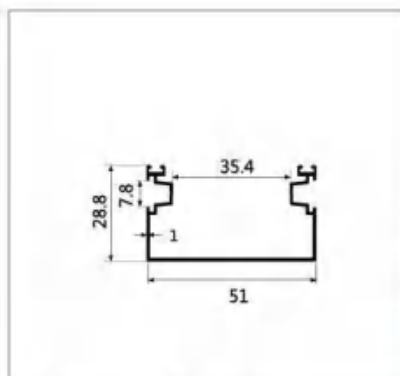

型号:LBW235 名称:双勾企  
壁厚:1.0mm 重量:0.38kg/m 长度:4.8m



现货颜色: 肌肤黑、优雅白、  
星巴咖啡、金属灰、土豪金、  
雪花梨木、丁香梨木、瓷美银灰、  
星空灰  
其他颜色可订制!

#### 35X65 推拉门配件

上轮 :SL-3565 (19.5*20)	边封胶条 :JT-211.216231236(4.5 偏)	不带缓冲吊轮 (凹轮) :DT-3548.3565A
下轮 :XL-3565-2 (15*21)	边封卡条 :KT-002(048)	单缓冲吊轮 (凹轮) :DT-3548.3565B
下轮 :XL-3565-2A (15*13)	边封毛条 :MT-02(5*6)	双缓冲吊轮 (凹轮) :DT-3548.3565C
光企角码 :JMS-3565-TLA (21*32)	勾企毛条 :MT-03(10*5)	单缓冲器 :TLHC-DX (单轨不可用)
光企角码 :JMS-3565-TLB (21*30.5)	不锈钢导轨 :XG-01	单缓冲器 :TLHC-DX-1
光企组角片 :ZJP-3548-TLA (5*1.2) 小	自粘不锈钢导轨 :XG-01-1	双缓冲器 :TLHC-SX (单轨不可用)
外框组角片 :ZJP-27327529235483565 (12.3*1.2)	边封堵头 :DT-35483565	
勾企胶条 :JT-209210235238(3.8)	不带缓冲吊轮 (平轮) :DT-3548.3565	



# 35x65 推拉 / 吊趟门系列 (壁厚 1.2/1.4/2.0)

高端系统门窗 - 定制极窄铝型材  
High-end system Doors and Windows - custom ultra-thin aluminum profiles

现货颜色: 肌肤黑、优雅白、星巴咖啡、金属灰、土豪金、雪花梨木、丁香梨木、瓷美银灰  
其他颜色可订制!

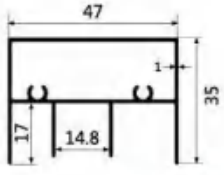
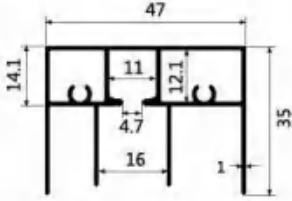
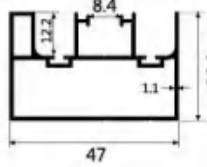
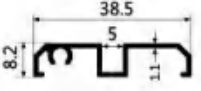
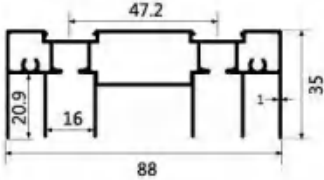
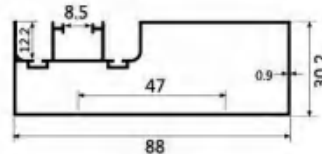
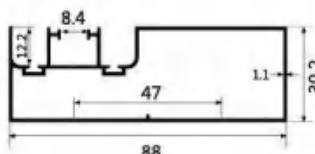
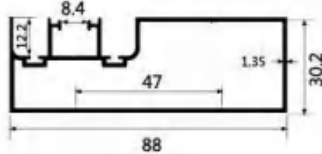
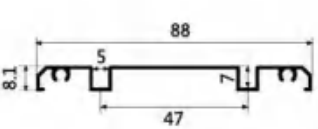
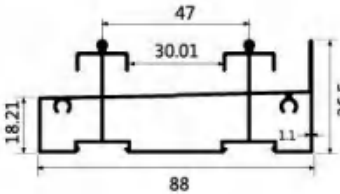
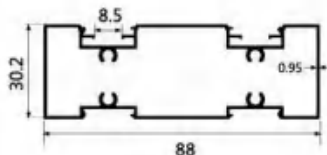
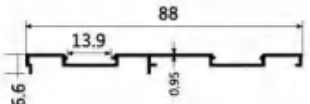
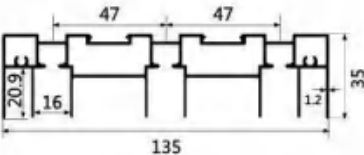
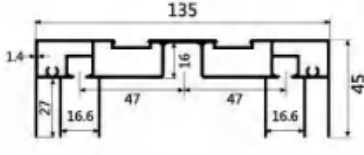
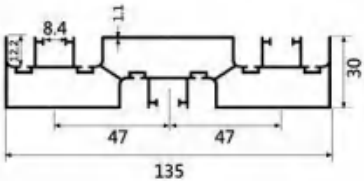
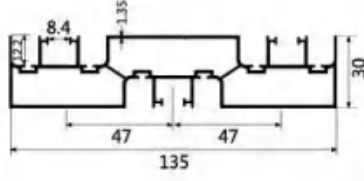
 <p>用完换 LBW380</p> <p>型号:LBW217 名称:单上轨 壁厚:1.0mm 重量:0.57kg/m 长度:6m</p>	 <p>型号:LBW380 名称:单上轨 壁厚:1.0mm 重量:0.66kg/m 长度:5.8m</p>	 <p>型号:LBW214 名称:单边封 壁厚:1.1mm 重量:0.65kg/m 长度:4.8m</p>	 <p>型号:LBW220 名称:单下轨 壁厚:1.2mm 重量:0.244kg/m 长度:6m</p>
 <p>型号:LBW218 名称:双上轨 壁厚:1.1mm 重量:1.2kg/m 长度:6m</p>	 <p>型号:LBW211 名称:1.0 双边封 壁厚:0.9mm 重量:0.74kg/m 长度:4.8m</p>	 <p>型号:LBW212 名称:1.2 双边封 壁厚:1.1mm 重量:0.87kg/m 长度:4.8m</p>	 <p>型号:LBW213 名称:1.4 双边封 壁厚:1.35mm 重量:1.031kg/m 长度:4.8m</p>
 <p>型号:LBW221 名称:双下轨 壁厚:1.1mm 重量:0.45kg/m 长度:6m</p>	 <p>型号:LBW223 名称:两轨高地轨 壁厚:1.1mm 重量:1.223kg/m 长度:6m</p>	 <p>型号:LBW226 名称:两轨中柱 壁厚:0.95mm 重量:0.91kg/m 长度:6m</p>	 <p>型号:LBW228 名称:两轨中柱盖板 壁厚:0.95mm 重量:0.33kg/m 长度:6m</p>
 <p>型号:LBW219 名称:三上轨 壁厚:1.2mm 重量:1.8kg/m 长度:6m</p>	 <p>型号:LBW233 名称:三联动上轨 壁厚:1.4 重量:2.11kg/m 长度:6m</p>	 <p>型号:LBW216 名称:1.2 三边封 壁厚:1.1mm 重量:1.56kg/m 长度:5.1m</p>	 <p>型号:LBW215 名称:1.4 三边封 壁厚:1.35mm 重量:1.855kg/m 长度:5.1m</p>



现货颜色: 肌肤黑、优雅白、星巴咖啡、金属灰、土豪金、雪花梨木、丁香梨木、瓷美银灰

其他颜色可订制!

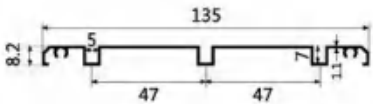
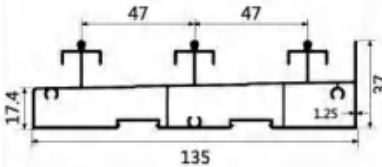
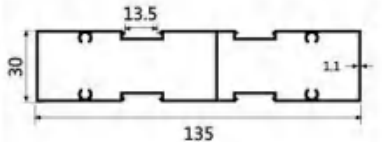
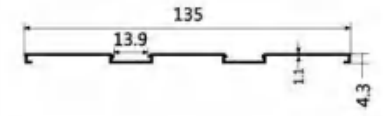
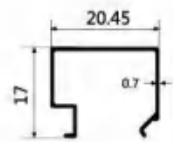
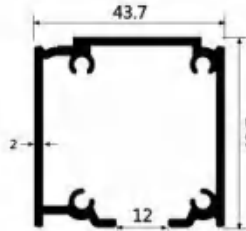
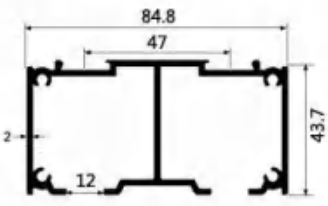
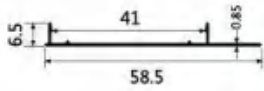
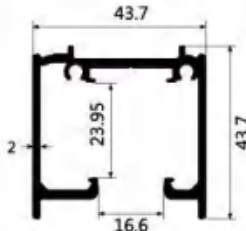
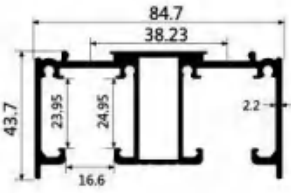
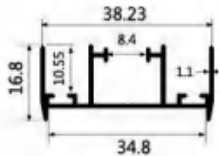
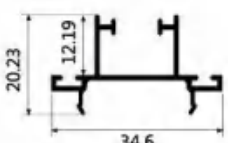
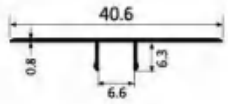
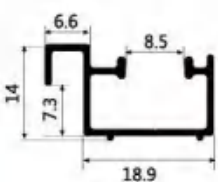
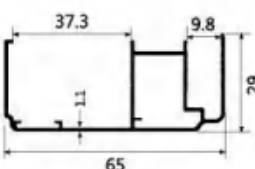
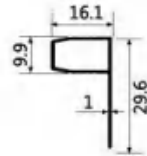
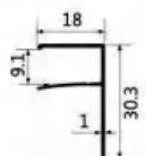

 <p>型号:LBW222 名称:三下轨 壁厚:1.1mm 重量:0.64kg/m 长度:6m</p>	 <p>型号:LBW230 名称:三轨高地轨 壁厚:1.25mm 重量:1.74kg/m 长度:6m</p>	 <p>型号:LBW227 名称:三轨中柱 壁厚:1.1mm 重量:1.313kg/m 长度:6m</p>	 <p>型号:LBW229 名称:三轨中柱盖板 壁厚:1.1mm 重量:0.49kg/m 长度:6m</p>	
 <p>型号:LBW232 名称:方形压线 壁厚:0.7mm 重量:0.12kg/m 长度:6m</p>	<p>颜色:黑珍珠</p>  <p>型号:LBW224 名称:单吊轨(平轮) 壁厚:2.0mm 重量:1.01kg/m 长度:6m</p>	<p>颜色:黑珍珠</p>  <p>型号:LBW225 名称:双吊轨(平轮) 壁厚:2.0mm 重量:1.65kg/m 长度:6m</p>	 <p>型号:LBW234 名称:吊轨盖板 壁厚:0.85mm 重量:0.164kg/m 长度:6.2m</p> <p>配套 LBW224 LBW225 LBW337 LBW381</p>	
<p>颜色:黑珍珠</p>  <p>型号:LBW381 名称:单轨吊轨(凹轮) 壁厚:2.0mm 重量:1.006kg/m 长度:6m</p>	<p>颜色:黑珍珠</p>  <p>型号:LBW237 名称:双吊轨(凹轮) 壁厚:2.2mm 重量:1.97kg/m 长度:6m</p>	 <p>型号:LBW236 名称:推拉收口 壁厚:1.0mm 重量:0.335kg/m 长度:4.8m</p>	<p>颜色:黑珍珠</p>  <p>型号:LBW231 名称:推拉收口 壁厚:1.0mm 重量:0.25kg/m 长度:4.8m</p>	
 <p>型号:LBW365 名称:35边封盖板 壁厚:0.8mm 重量:0.11kg/m 长度:5.1m</p> <p>配套 35 中窄边封</p>	<p>颜色:黑珍珠</p>  <p>型号:LBW336 名称:纱网料 壁厚:1.0mm 重量:0.18kg/m 长度:6m</p>	 <p>型号:LBW244 名称:前框/包边 壁厚:1.1mm 重量:0.562kg/m 长度:6.4m</p>	 <p>型号:LBW045 名称:三分P槽 壁厚:1.0mm 重量:0.170kg/m 长度:4.8m</p>	 <p>型号:LBW079 名称:三分F槽 壁厚:1.0mm 重量:0.165kg/m 长度:6.2m</p>



就是这样子装的

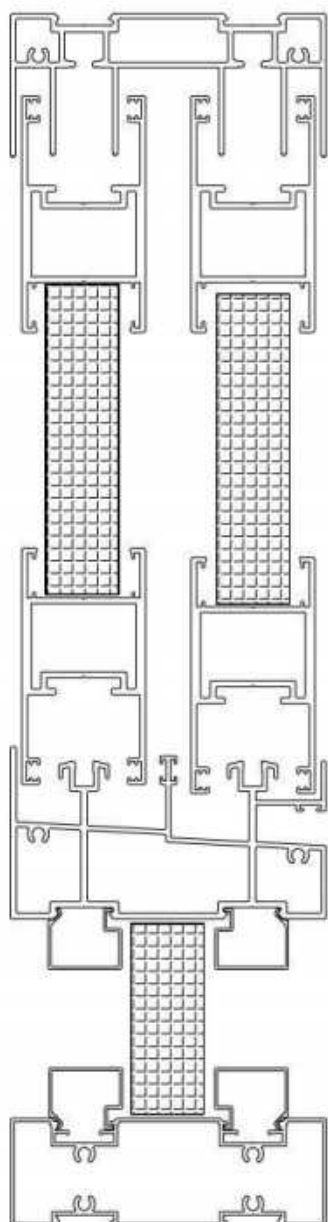
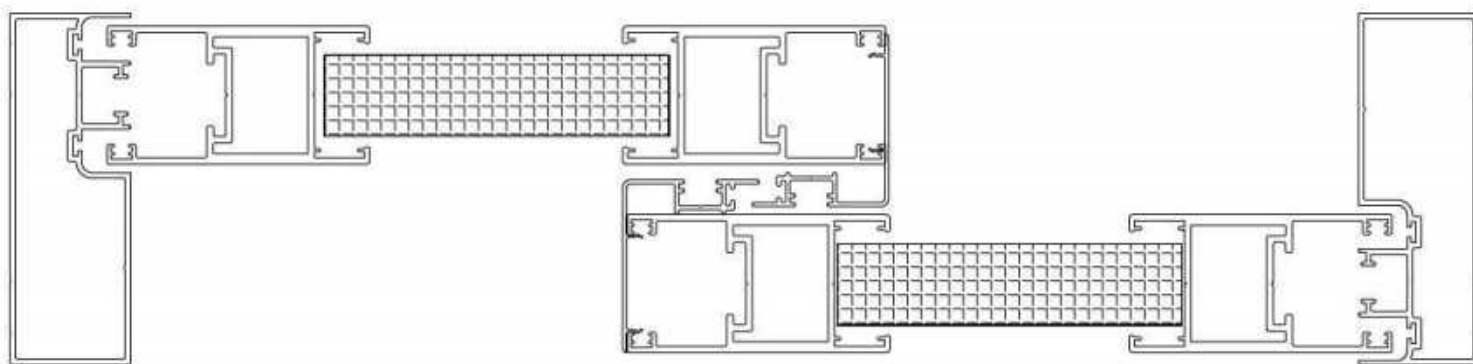

你的工作能力真是出众。

# 35x65 封窗系列

高端系统门窗 - 定制铝型材  
High-end system doors and windows - custom aluminum profiles

现货颜色：玳瑁黑、星巴咖啡、金属灰、土豪金、砂灰、星空灰

其他颜色可订制!

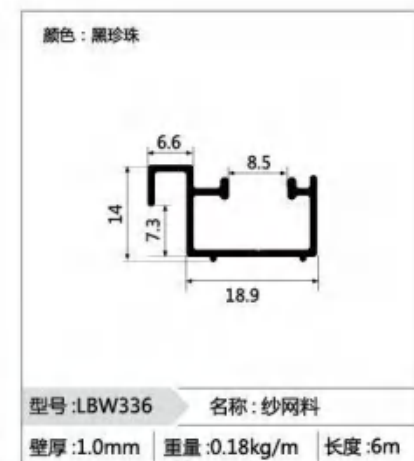
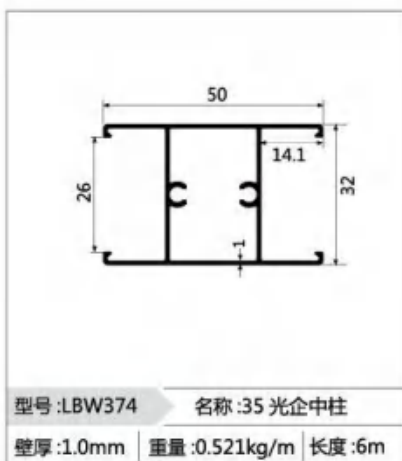
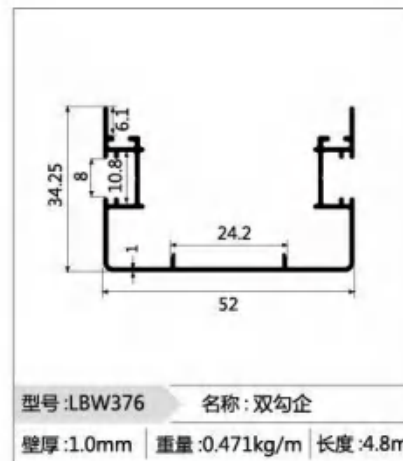
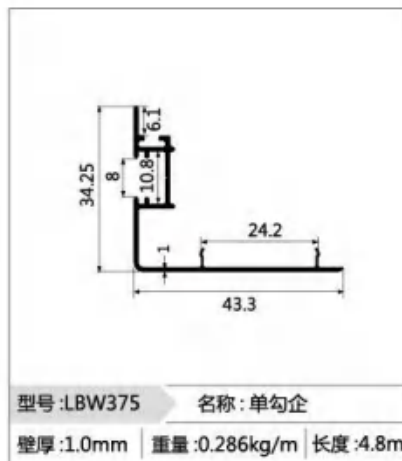
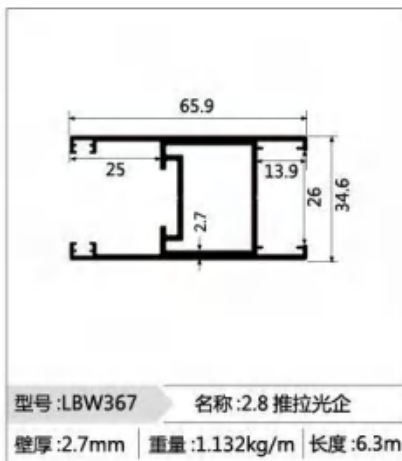
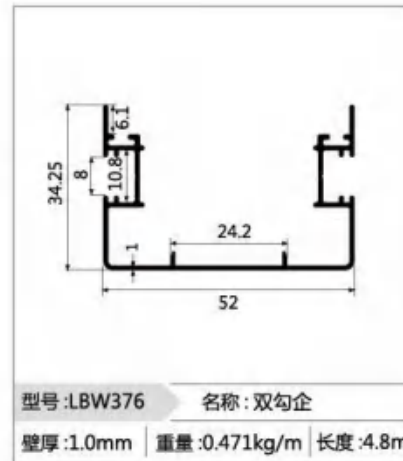
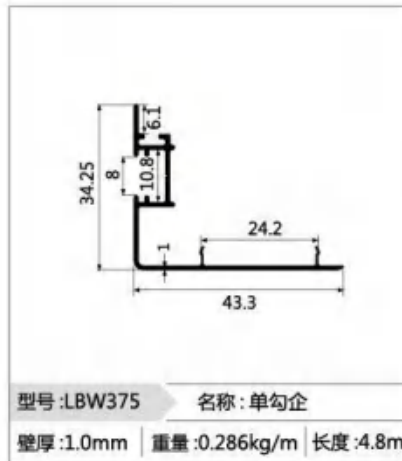
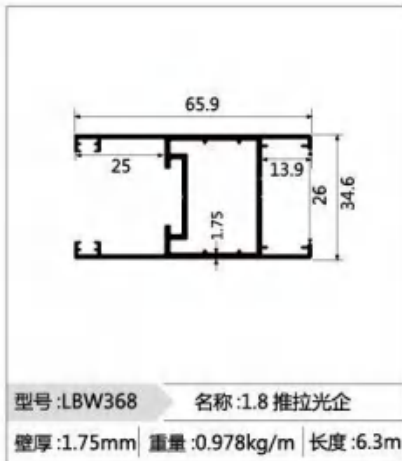
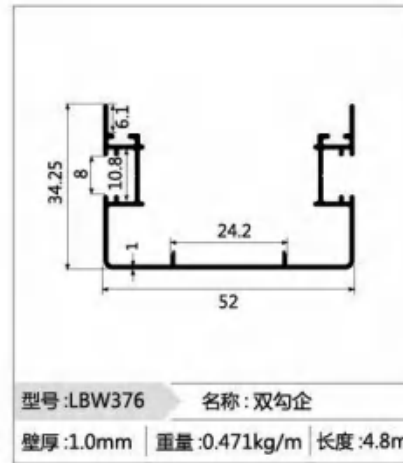
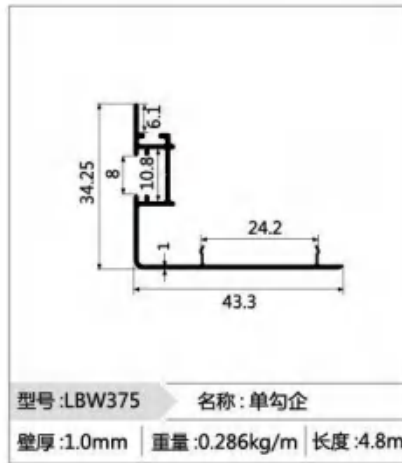
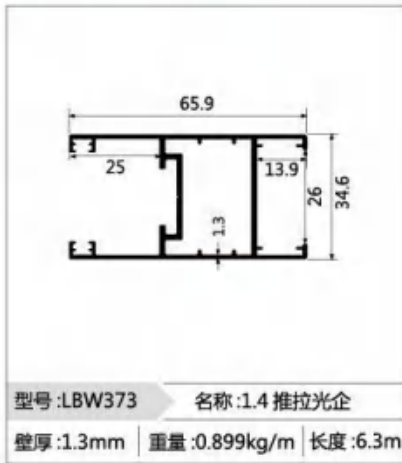

现货颜色：玳瑁黑、星巴咖啡、金属灰、土豪金、砂灰、星空灰

其他颜色可订制!



玳瑁黑



星巴咖啡



金属灰



土豪金



砂灰



星空灰



现货颜色：玳瑁黑、星巴咖啡、金属灰、土豪金、砂灰、星空灰

其他颜色可订制!

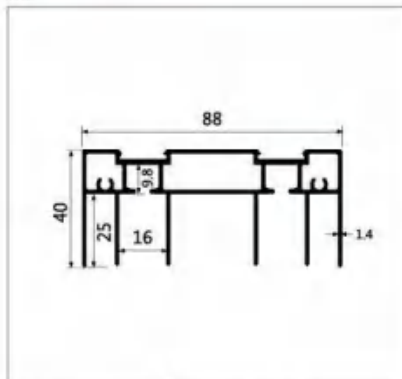

型号:LBW357 名称:双上轨  
壁厚:1.4mm 重量:1.614kg/m 长度:6m

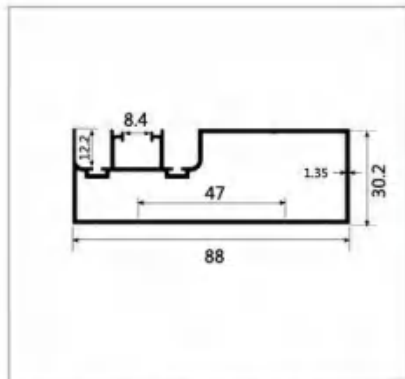

型号:LBW213 名称:1.4 双边封  
壁厚:1.35mm 重量:1.031kg/m 长度:4.8m

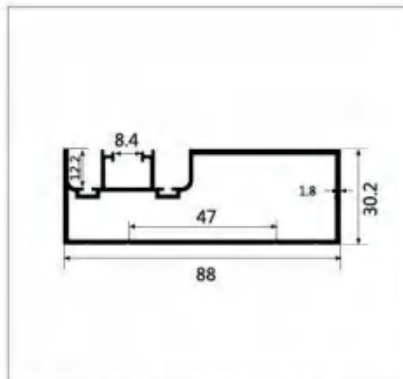

型号:LBW383 名称:2.0 双边封  
壁厚:1.8mm 重量:1.2kg/m 长度:4.8m

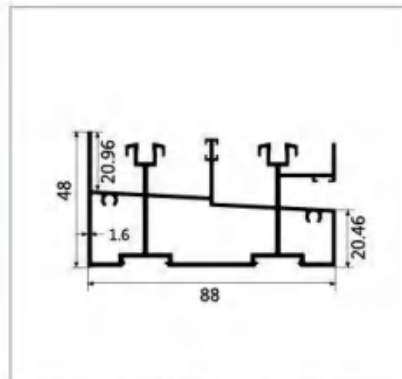

型号:LBW371 名称:两轨高地轨  
壁厚:1.6mm 重量:1.846kg/m 长度:6m

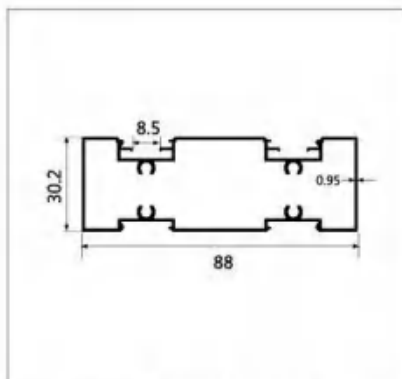

型号:LBW226 名称:两轨中柱  
壁厚:0.95mm 重量:0.91kg/m 长度:6m

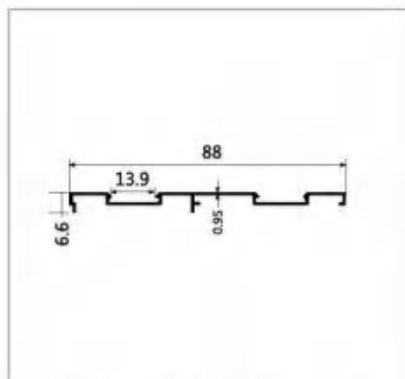

型号:LBW228 名称:两轨中柱盖板  
壁厚:0.95mm 重量:0.33kg/m 长度:6m

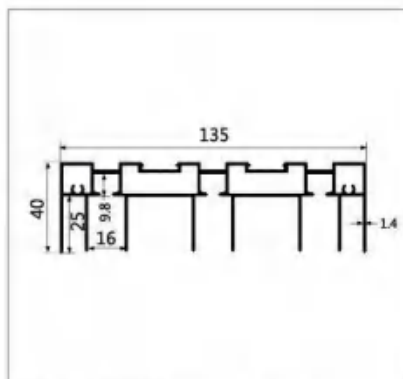

型号:LBW358 名称:三上轨  
壁厚:1.4mm 重量:2.286kg/m 长度:6m

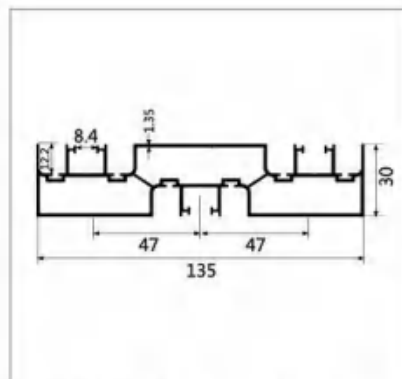

型号:LBW215 名称:1.4 三边封  
壁厚:1.35mm 重量:1.855kg/m 长度:5.1m

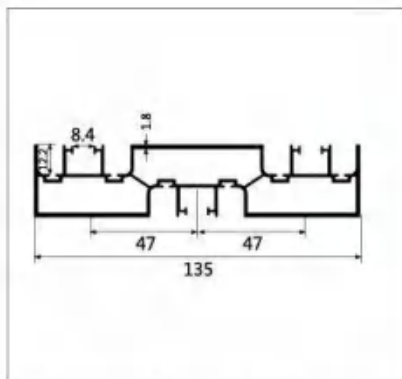

型号:LBW384 名称:2.0 三边封  
壁厚:1.8mm 重量:2.12kg/m 长度:5.1m

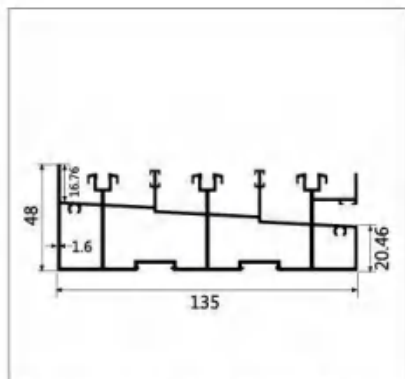

型号:LBW372 名称:三轨高地轨  
壁厚:1.6mm 重量:2.623kg/m 长度:6m

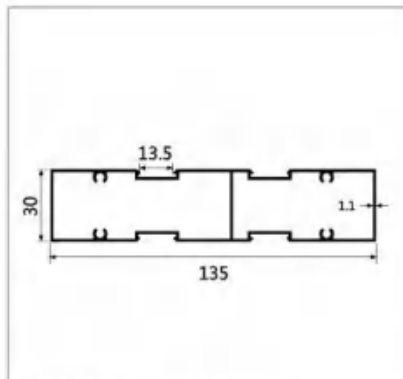

型号:LBW227 名称:三轨中柱  
壁厚:1.1mm 重量:1.313kg/m 长度:6m

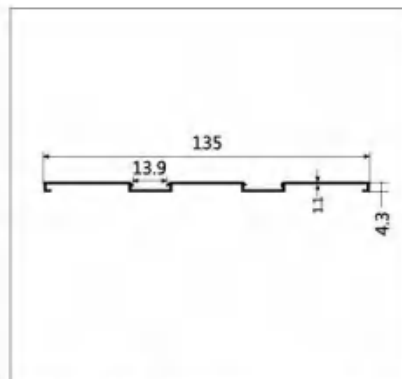

型号:LBW229 名称:三轨中柱盖板  
壁厚:1.1mm 重量:0.49kg/m 长度:6m

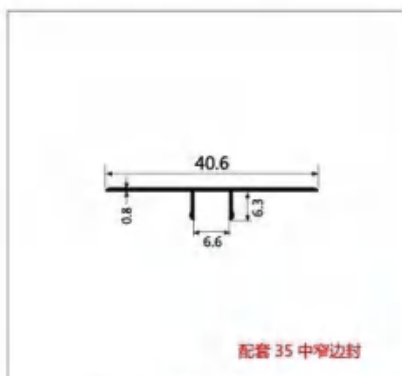

配套 35 中窄边封

型号:LBW365 名称:35 边封盖板  
壁厚:0.8mm 重量:0.11kg/m 长度:5.1m

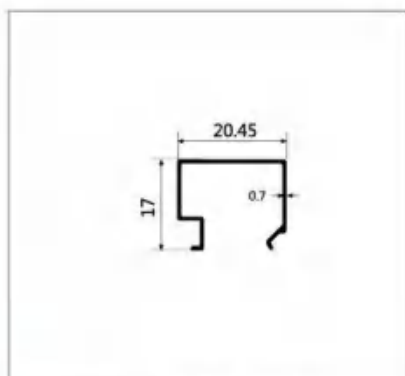

型号:LBW232 名称:方形压线  
壁厚:0.7mm 重量:0.12kg/m 长度:6m



现货颜色：玳瑁黑、星巴咖啡、金属灰、土豪金、砂灰、星空灰

其他颜色可订制!



玳瑁黑



星巴咖啡



金属灰



土豪金



砂灰



星空灰

就是这样子装的

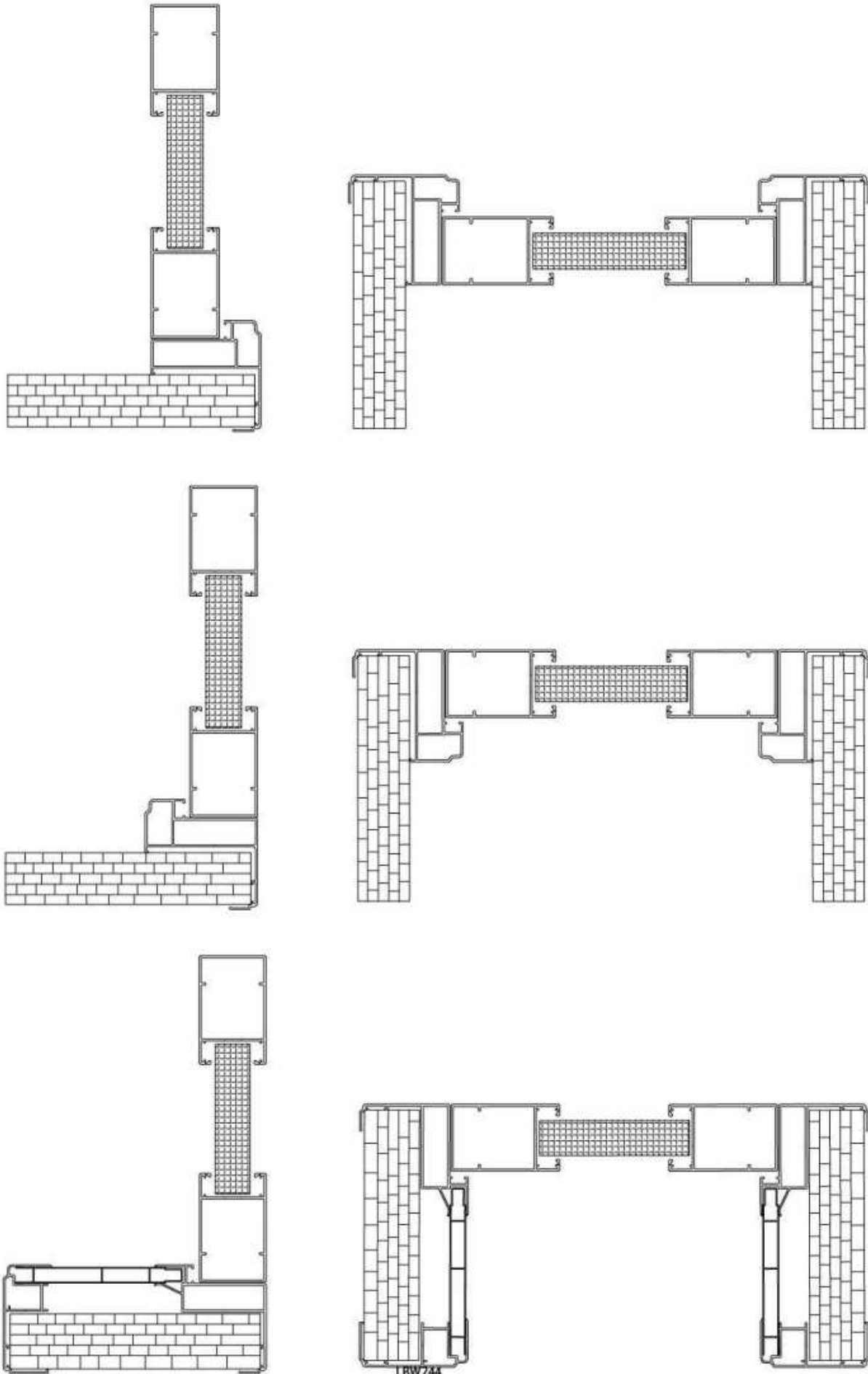



现货颜色：砂灰、星巴咖啡、金属灰、珐琅黑、土豪金、星空灰

其他颜色可订制!

42X65 平开门系列

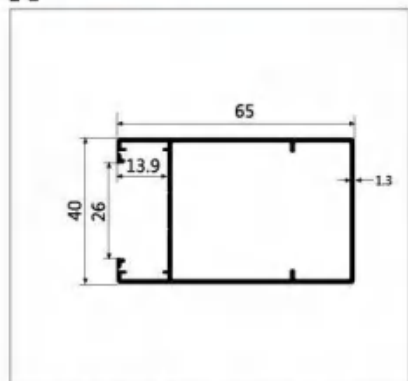

型号:LBW241 名称:1.4 平开光企  
壁厚:1.3mm | 重量:0.8kg/m | 长度:5.8m

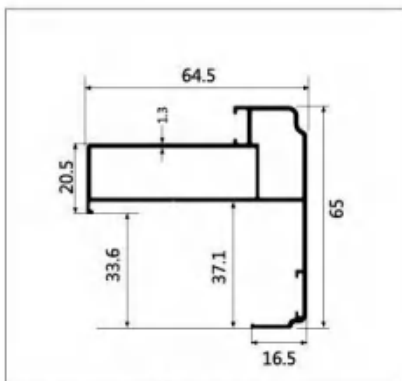

型号:LBW242 名称:1.4 外包  
壁厚:1.3mm | 重量:0.86kg/m | 长度:6.4m

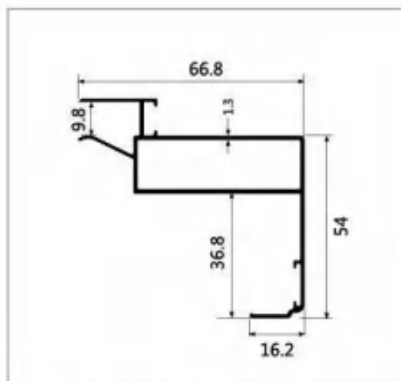

型号:LBW243 名称:1.4 后框  
壁厚:1.3mm | 重量:0.78kg/m | 长度:6.4m

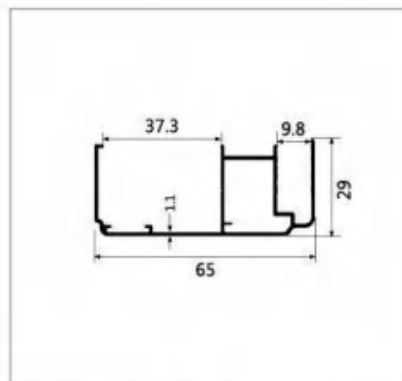

型号:LBW244 名称:前框/包边  
壁厚:1.1mm | 重量:0.562kg/m | 长度:6.4m

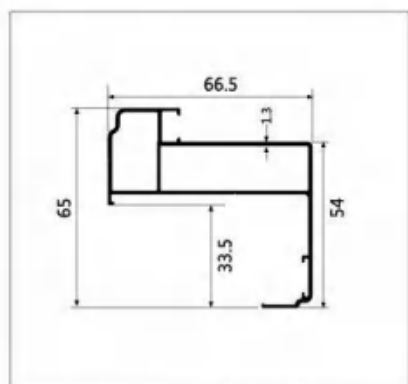

型号:LBW305 名称:1.4 内包  
壁厚:1.3mm | 重量:0.855kg/m | 长度:6.4m

我妈安慰我说，

浪子回头金不换！

谁给我金子？我换

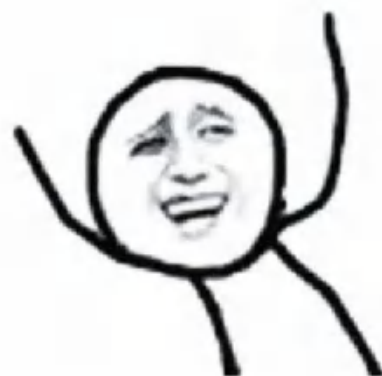

42x65 中窄平开门配件	
平开锁整套：	3565/4265 平开锁（裸锁）28面
	39 可调锁盒
	4265 锁芯胶 L6540
	30 锁芯胶 3565/4265
光企角码：塑	外挂合页：左右 (14*18)
外框角码：(14*47)	天地合页：左右 (14*18)
包边角码：(14*18)	外框组角片：(12.3*1.2)
胶条：(8.7)	

现货颜色：砂灰、星巴咖啡、金属灰、珐琅黑、土豪金、星空灰

其他颜色可订制!



珐琅黑

星巴咖啡

金属灰

土豪金

砂灰

星空灰

就是这样子装的

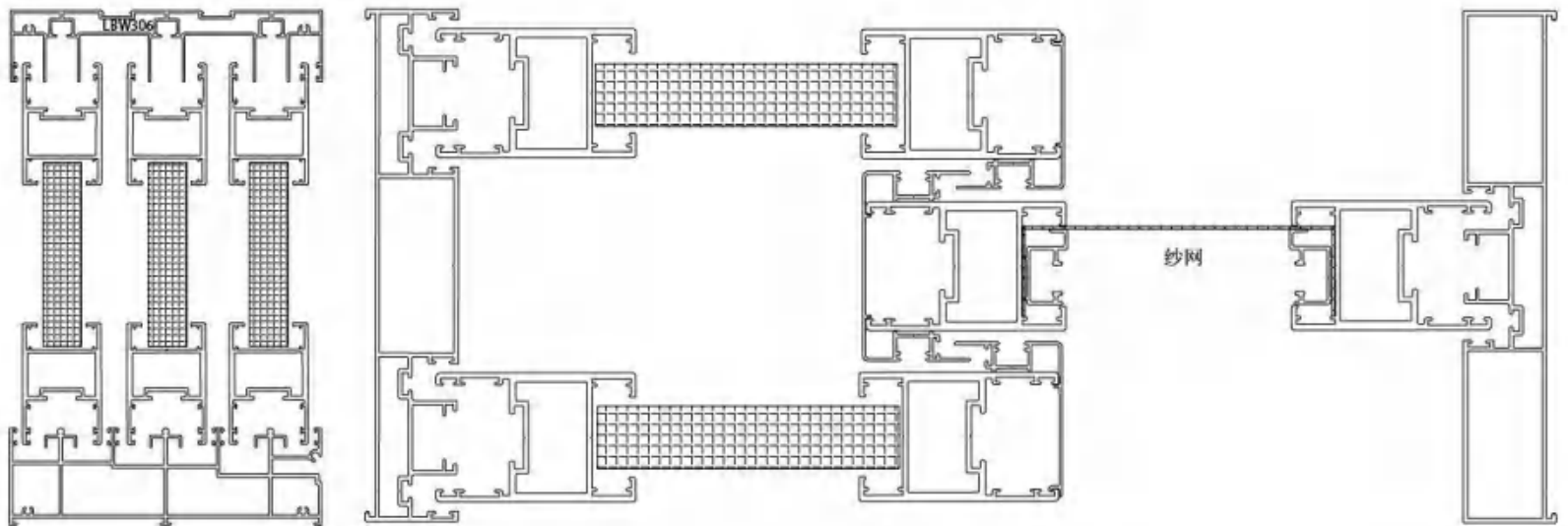

42X65 推拉门配件

上轮 :SL-42100 (19.5*26)	光企角码 3.0:JM-4265-327 (19*36)	边封卡条 :KT-002(048)	不锈钢导轨 :XG-01
上轮 :SL-4265 (19.5*21)	光企角码 5.0:JM-4265-328 (19*31.5)	边封堵头 :DT-212	自粘不锈钢导轨 :XG-01-1
下轮 :XL-4265 (15*24) 两轮	光企角码 :JM-320-TL	边封卡条 :KT-003(0401)	光企组角片 :ZJP-3548-TLA (5*1.2) 小
下轮 :XL-42100 (15*27) 四轮	边密封胶条 :JT-307308314(6.2)	单缓冲器 :TLHC-DX (单轨不可用)	外框组角片 :ZJP-27327529235483565 (12.3*1.2)
地轨下轮 :XL-3548-2 (15*17) 两轮	勾企胶条 :JT-321322329330(5.8)	单缓冲器 :TLHC-DX-1	光企组角片 :ZJP-42100A (13.6*1.0) 大
地轨下轮 :XL-3565-2 (15*21) 两轮	边封毛条 :MT-02(5*6)	双缓冲器 :TLHC-SX (单轨不可用)	光企组角片 :ZJP-42100B (7*1.2) 小
光企角码 1.4:JM-4265-246A (19*38.5)	勾企毛条 :MT-03(10*5)		

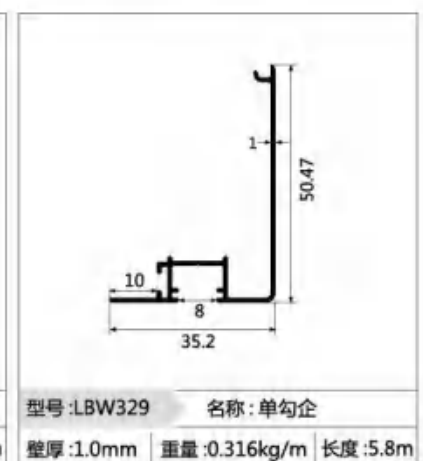
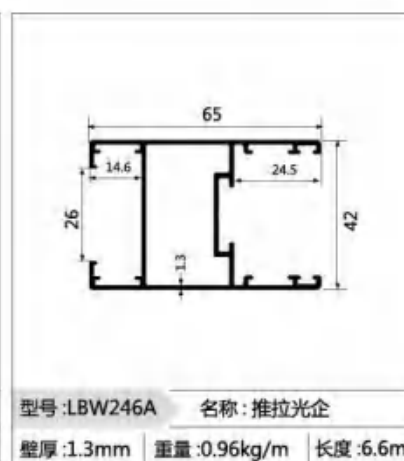
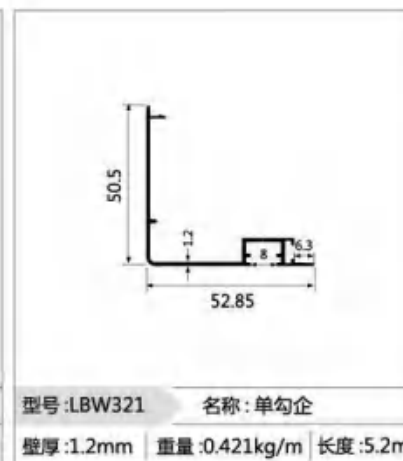
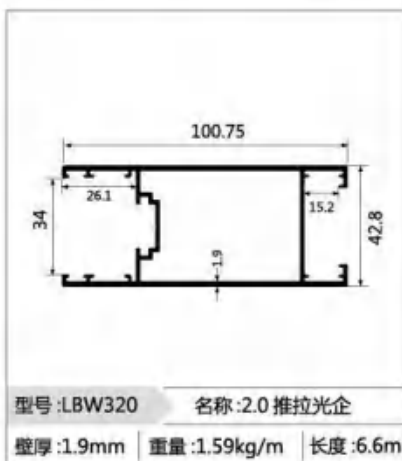

现货颜色：砂灰、星巴咖啡、金属灰、珐琅黑、土豪金



其他颜色可订制!

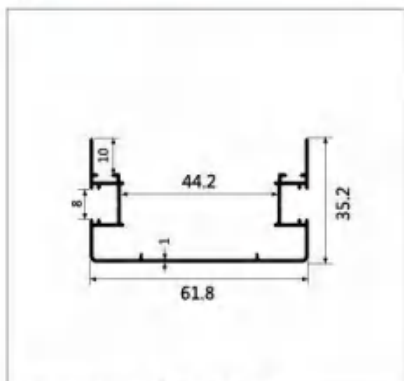

型号:LBW330 名称:双勾企  
壁厚:1.0mm 重量:0.52kg/m 长度:5.2m

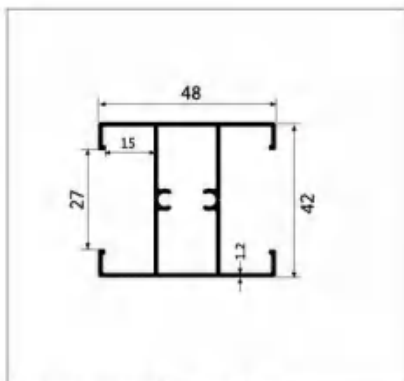

型号:LBW323 名称:中柱  
壁厚:1.2mm 重量:0.722kg/m 长度:6.3m

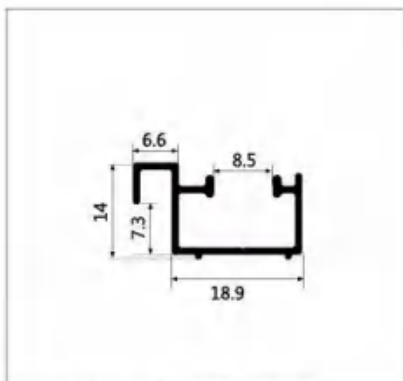

型号:LBW336 名称:纱网料  
壁厚:1.0mm 重量:0.18kg/m 长度:6m

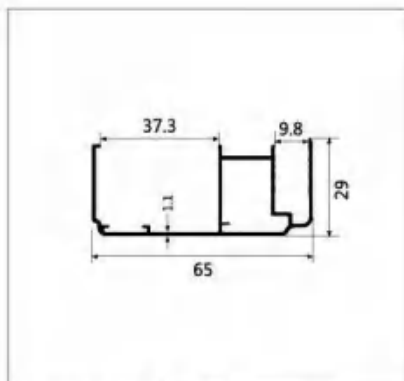

型号:LBW244 名称:前框/包边  
壁厚:1.1mm 重量:0.562kg/m 长度:6.4m

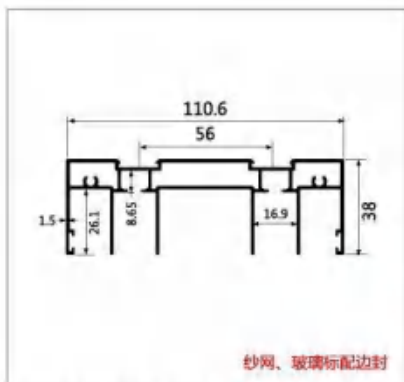

纱网、玻璃标配边封

型号:LBW313 名称:双上轨  
壁厚:1.5mm 重量:1.62kg/m 长度:6.3m

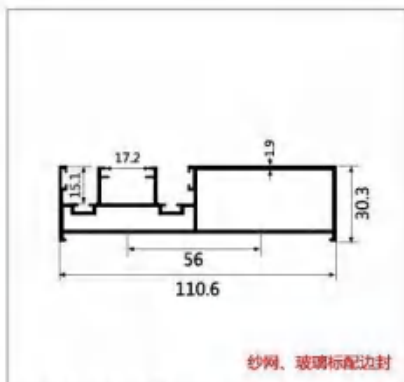

纱网、玻璃标配边封

型号:LBW314 名称:2.0 双边封  
壁厚:1.9mm 重量:1.6kg/m 长度:5.6m

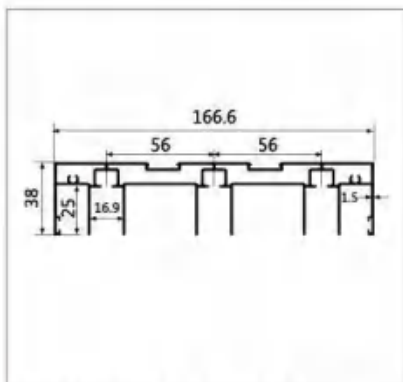

型号:LBW306 名称:三上轨  
壁厚:1.5mm 重量:2.37kg/m 长度:6.3m

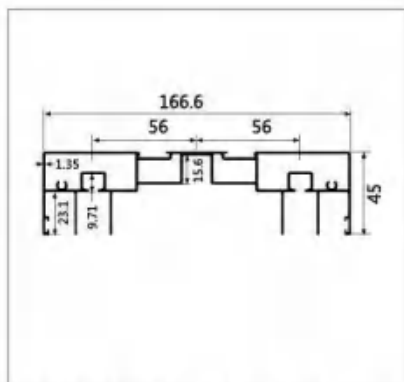

型号:LBW351 名称:三联上轨  
壁厚:1.35mm 重量:2.435kg/m 长度:6.3m

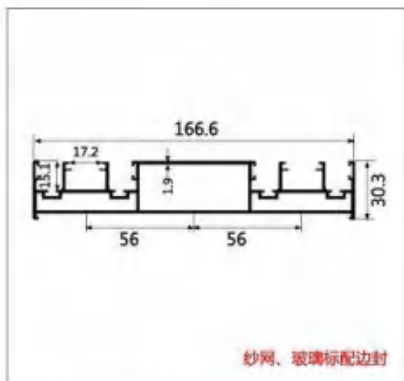

纱网、玻璃标配边封

型号:LBW307 名称:2.0 三边封  
壁厚:1.9mm 重量:2.4kg/m 长度:5.6m

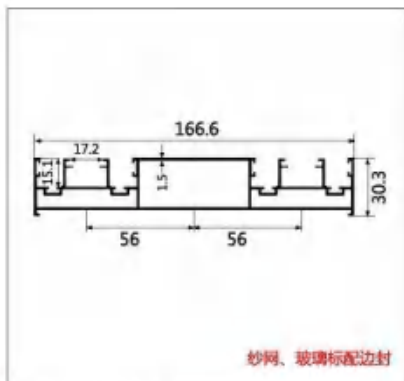

纱网、玻璃标配边封

型号:LBW307A 名称:1.6 三边封  
壁厚:1.5mm 重量:2.1kg/m 长度:5.6m

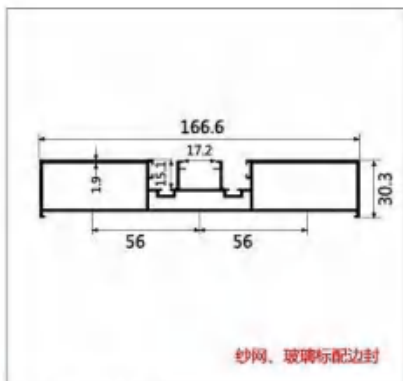

纱网、玻璃标配边封

型号:LBW308 名称:2.0 三边封  
壁厚:1.9mm 重量:2.24kg/m 长度:5.6m

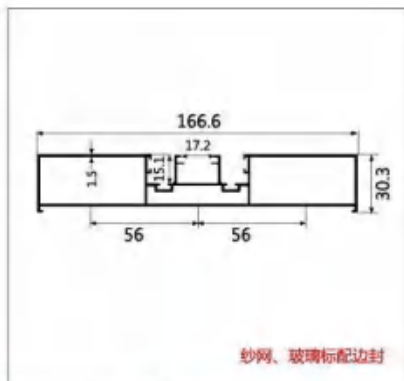

纱网、玻璃标配边封

型号:LBW308A 名称:1.6 三边封  
壁厚:1.5mm 重量:1.88kg/m 长度:5.6m

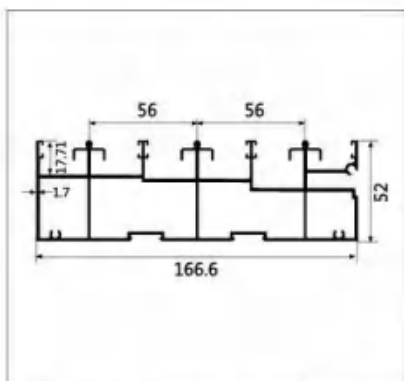

型号:LBW309 名称:三轨高地轨  
壁厚:1.7mm 重量:3.3kg/m 长度:6.3m

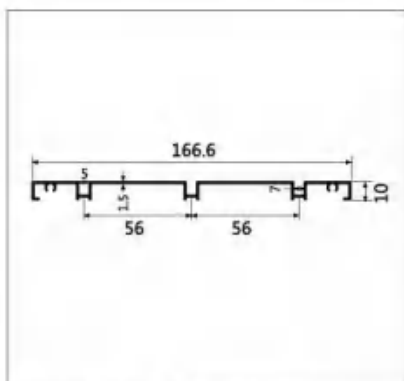

型号:LBW310 名称:三下轨  
壁厚:1.5mm 重量:1.04kg/m 长度:6.3m

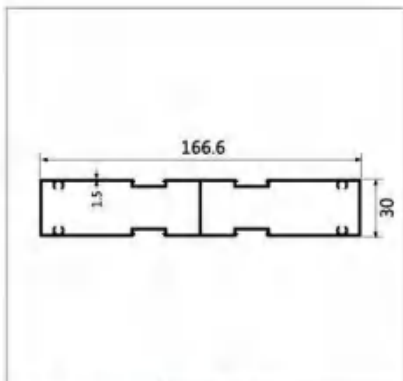

型号:LBW311 名称:三轨中柱  
壁厚:1.5mm 重量:1.94kg/m 长度:6.3m

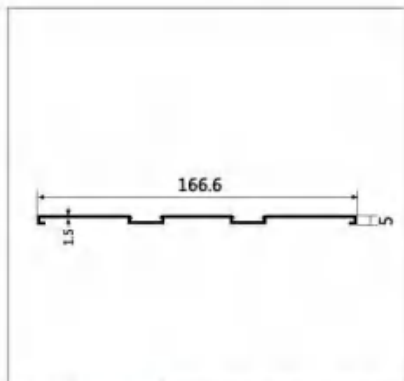

型号:LBW312 名称:三轨中柱盖板  
壁厚:1.5mm 重量:0.8kg/m 长度:6.3m



# 42x65 重型推拉 / 吊趟门系列

高端系统门窗 - 定制极窄铝型材  
High-end system doors and windows - custom ultra-thin aluminum profiles

现货颜色：砂灰、星巴咖啡、金属灰、珐琅黑、土豪金

其他颜色可订制!

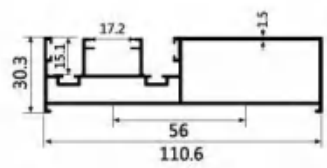
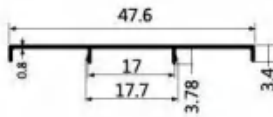
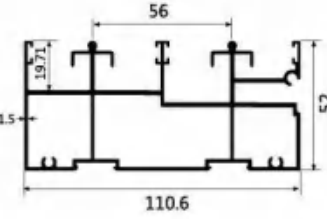
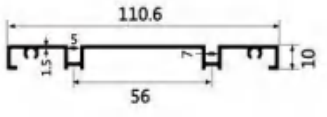

	 <p style="color: red; text-align: center;">配套 42 重型边封</p>		
<p>型号:LBW314A 名称:1.6 双边封 壁厚:1.5mm 重量:1.38kg/m 长度:5.6m</p>	<p>型号:LBW366 名称:边封盖板 壁厚:0.8mm 重量:0.128kg/m 长度:5.6m</p>	<p>型号:LBW315 名称:两轨高地轨 壁厚:1.5mm 重量:2.31kg/m 长度:6.3m</p>	<p>型号:LBW316 名称:双下轨 壁厚:1.5mm 重量:0.742kg/m 长度:6.3m</p>

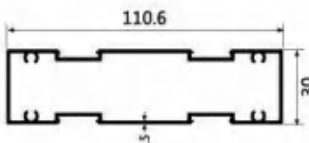
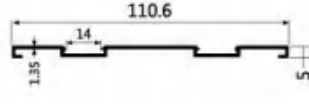
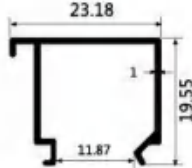
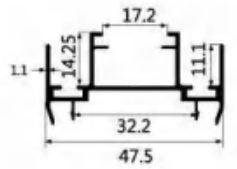
			
<p>型号:LBW317 名称:两轨中柱 壁厚:1.5mm 重量:1.37kg/m 长度:6.3m</p>	<p>型号:LBW318 名称:两轨中柱盖板 壁厚:1.35mm 重量:0.52kg/m 长度:6.3m</p>	<p>型号:LBW319 名称:压线 壁厚:1.0mm 重量:0.183kg/m 长度:6.3m</p>	<p>型号:LBW324 名称:推拉收口 壁厚:1.1mm 重量:0.466kg/m 长度:5.2m</p>

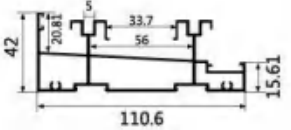
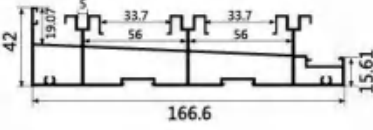
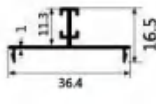
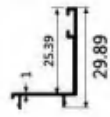
		 <p style="color: red; text-align: center;">配套 LBW363 LBW364</p>	 <p style="color: red; text-align: center;">配套 LBW363 LBW364</p>
<p>型号:LBW363 名称:两轨高地轨 壁厚:1.5mm 重量:1.764kg/m 长度:6.3m</p>	<p>型号:LBW364 名称:三轨高地轨 壁厚:1.5mm 重量:2.517kg/m 长度:6.3m</p>	<p>型号:LBW369 名称:高地轨盖板 壁厚:1.0mm 重量:0.199kg/m 长度:6.3m</p>	<p>型号:LBW370 名称:高地轨边盖 壁厚:1.3mm 重量:0.174kg/m 长度:6.3m</p>

现货颜色：砂灰、星巴咖啡、金属灰、珐琅黑、土豪金、星空灰

其他颜色可订制!

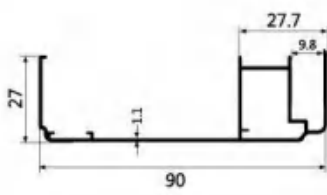

<p>型号:LBW245 名称:包边 壁厚:1.1mm 重量:0.633kg/m 长度:6.4m</p>

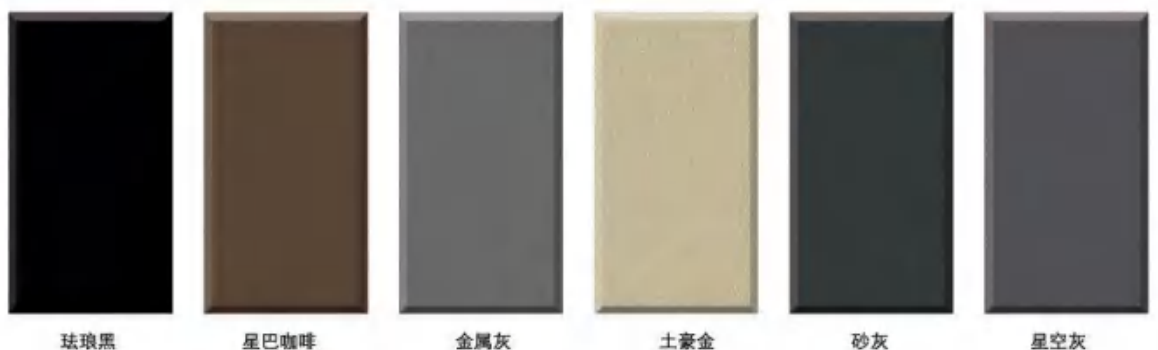

珐琅黑

星巴咖啡

金属灰

土豪金

砂灰

星空灰



现货颜色：玳瑁黑

其他颜色可订制!



<p>型号:LBW110 名称:隔断平开门外框 壁厚:1.5mm 重量:0.649kg/m 长度:6.4m</p>	<p>型号:LBW111 名称:隔断压线 壁厚:1.0mm 重量:0.154kg/m 长度:6m</p>	<p>型号:LBW112 名称:隔断中柱 壁厚:3.1mm 重量:1.333kg/m 长度:6m</p>	<p>型号:LBW113 名称:隔断边封 壁厚:3.1mm 重量:1.223kg/m 长度:6m</p>

## 16单玻隔断平开门装配图

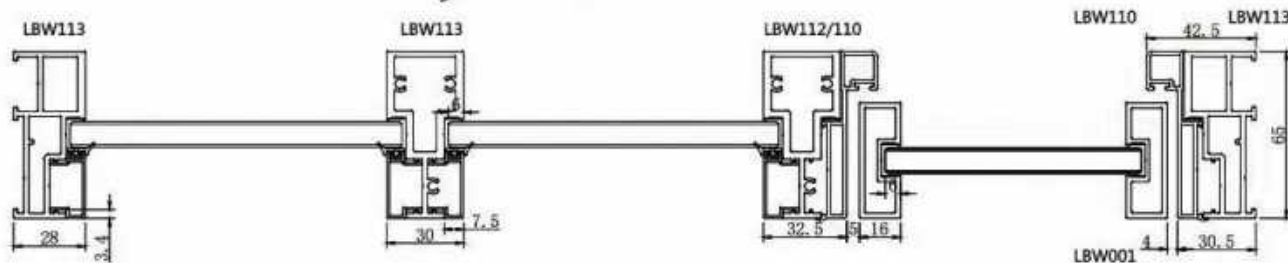
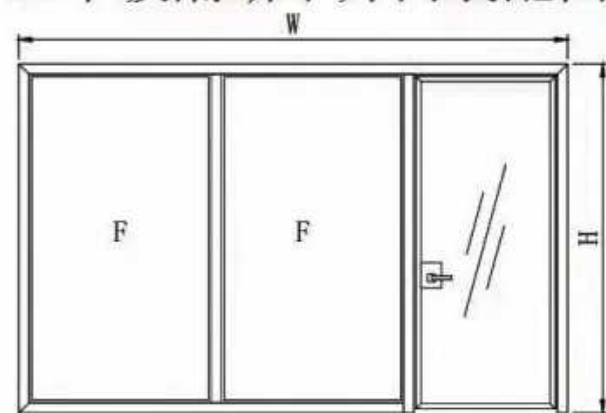

现货颜色：玳瑁黑

其他颜色可订制!



故事讲完了，我下班了!!

你下单吧!!



玳瑁黑